

ELECTRONIC VALVES

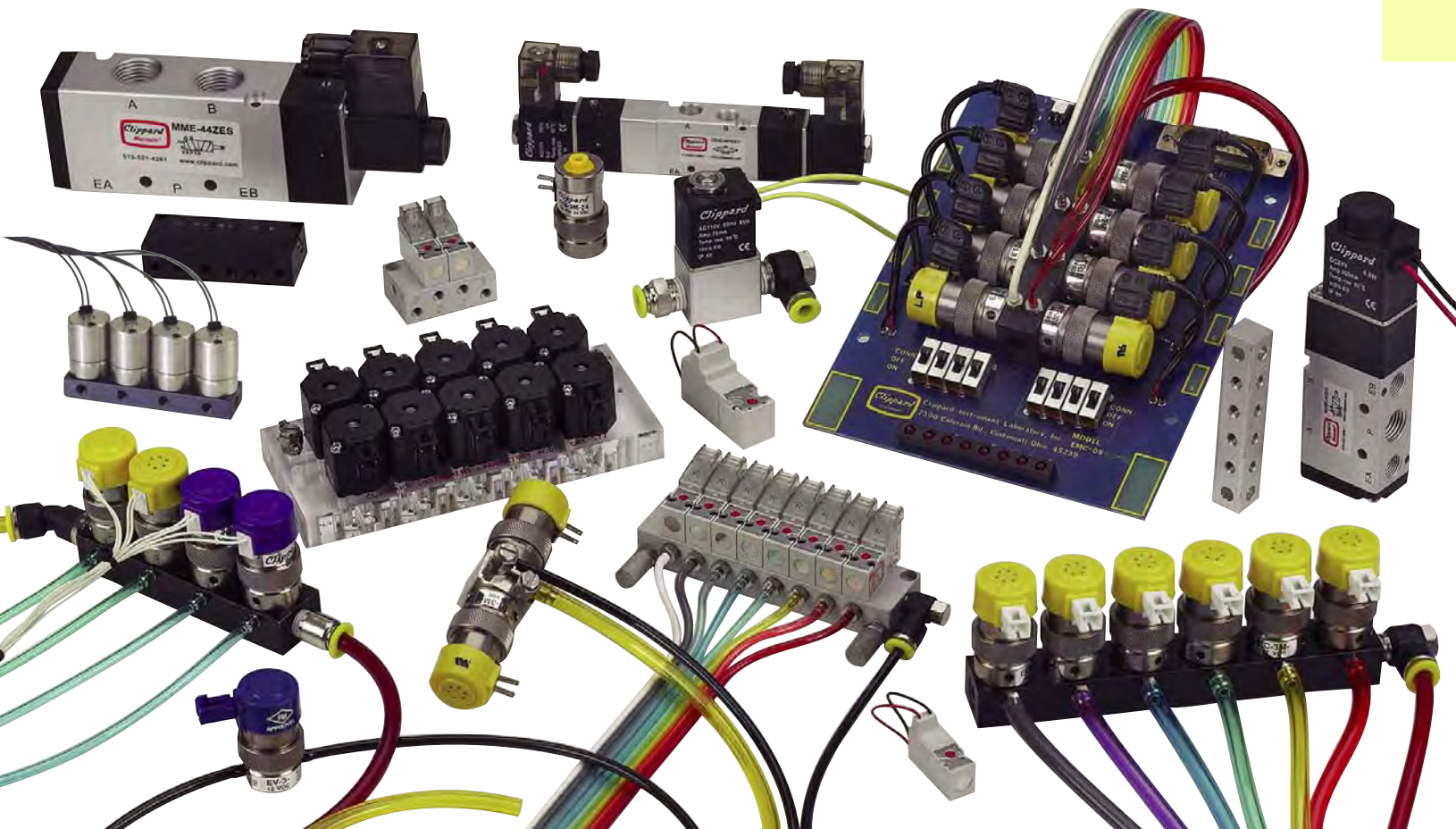

<u>MOUSE VALVE SERIES (EV, ET, EC, EW SERIES)</u>	<u>169 - 182</u>
<u>OXYGEN CLEAN, NEW! ANALYTICAL & CORROSION-RESISTANT SERIES VALVES</u>	<u>173 - 180</u>
<u>INTRINSICALLY SAFE VALVES</u>	<u>182</u>
<u>ELECTRONIC VALVE ACCESSORIES</u>	<u>183 - 185</u>
<u>ELECTRONIC MANIFOLD CARDS</u>	<u>186 - 187</u>
<u>EVP SERIES PROPORTIONAL CONTROL VALVES</u>	<u>188 - 190</u>
NEW! <u>PROPORTIONAL VALVE DRIVER</u>	<u>191</u>
NEW! <u>STEPPER-CONTROLLED PROPORTIONAL VALVE</u>	<u>192 - 193</u>
<u>EM SERIES STUD MOUNTED VALVES</u>	<u>194 - 195</u>
<u>ES, ESO SERIES COMPACT VALVES</u>	<u>196 - 200</u>
EXPANDED! <u>10 MM & 15 MM MINIATURE VALVES</u>	<u>201 - 214</u>
<u>MAXIMATIC® SOLENOID VALVES</u>	<u>215 - 225</u>





ELECTRONIC VALVES OVERVIEW

Mouse Valve Series



- Industry standard for leak-free operation
- Fast response
- Low power
- 1,000,000,000+ cycle life
- Low heat rise
- Quiet operation

Proportional Valve Series



- Direct-operated
 - Low hysteresis
- EVP Series***
- Fast response
 - High cycle life
- SCPV Series***
- High flow
 - Stepper-controlled
 - Excellent linearity

10 & 15 mm Valve Series

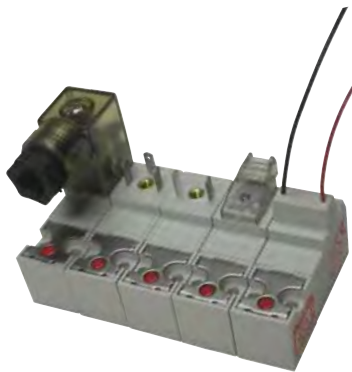

- 2- or 3-way operation
- Detachable coil and connector for orientation options
- Variety of electrical circuit features
- Manifold options available

Maximatic® Valve Series



- General purpose, 2-, 3- and 4-way configurations
- Maximum Value, Maximum Performance
- Direct- and pilot-operated
- Manifold or in-line mounting
- NAMUR style
- Same-day shipping for most models

Custom Electronic Valves

With years of engineering and technical experience, Clippard continues to be a leader in manufacturing special products for a broad spectrum of industries.



Not your every day 10 or 15 mm valves!

Specially-designed high-flow 2-way valves that can pass twice as much gas or liquid flow than other valves.



Integrated Solutions

How else can we make it easy? This application requires special pressure decay testing and the assembly of customer-specified fittings, connector and special labeling.



Custom Ports & Connectors

The application requires a special connection to a gas canister. The valve is tested for response time and flow rate, which delivers a consistent amount of gas each cycle.

Clippard “Mouse” Series Electronic Valves

- **Functional Simplicity—One Moving Part!**
- **1,000,000,000+ Cycle Life**
- **Fast Response**
- **Low Heat Rise**
- **Quiet Operation**
- **Industry Standard for Leak-Free Operation**
- **Low Power**



EV Series

2- and 3-way manifold and in-line mounting. Normally-Closed and fully-ported versions.

See Pages 171 - 179.



Proportional Control Series

Proportional control provides variable output flow. 2-way only.

See Pages 188 - 190.



Corrosion-Resistant Series

Enhanced plating and some stainless steel components add to the life of this valve used with mildly corrosive media, such as moisture in air or gases.

See Pages 171 - 179.



Intrinsically Safe Series

Low power and suited for Intrinsically Safe barriers.

See Page 182.



Oxygen Clean EV Series

Specially-cleaned valves for analytical or Oxygen use.

See Pages 171 - 179.



EM Series

The smallest valve in this series, for applications requiring high-density valve population.

See Pages 194 - 195.



NEW! Analytical EV Series

Specially-cleaned valves for special needs of the analytical industry.

See Pages 171 - 179.



ES Series

Alternate mounting with same compact design and reliability.

See Pages 196 - 200.



ECN, EVN, ETN Series

Normally-Open, manifold mount to allow Normally-Closed and Normally-Open valves on the same manifold.

See Page 181.



ELECTRONIC MOUSE VALVE SERIES



2020/2021 High Flow 3-Way Valves

Piloted by a Clippard EC, EV, ET or EW manifold mount electronic valve, the 2020/2021 produces outputs up to 22 scfm at 100 psig. Combines low wattage, long life and cool running of the "E" series valves with quick response and high flow of Fluidamp type valves.

[See Page 183.](#)



EVB Booster Series

Electronic Valve Boosters amplify the flow capacity of EC, EV and ET type valves by over eight

times. Manifold style electronic valves mount onto booster body, which, in turn, mounts on Clippard manifolds.

[See Page 183.](#)



2013 Series Electronic Fluidamp

Low-power DC solenoid solid state output signals can be

directly converted to high pressure pneumatic power without amplification.

[See Page 183.](#)

Manifolds



Pilot Manifold

Clippard's ET valve is mounted to the 15491-1 Clippard Pilot manifold, making it possible for the ET-3M valve controlled by an electronic signal to actuate a larger air-piloted valve or an air cylinder.

[See Page 185.](#)



Dual-Supply Manifold

Shown is the 15490-3 Clippard Dual-Supply Manifold with two ET-3M electronic/pneumatic interface valves. 1/8" NPT inlet is seen at the left of the manifold with the dual #10-32 port outlets at the right.

[See Page 185.](#)

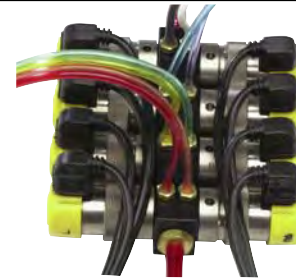

Multi-Valve Manifolds

Multi-valve manifolds are available with either single or double (top or top and bottom) rows of outputs for versatility in application. Input to all valves mounted on this manifold is through the manifold end. Outputs are individual #10-32 ports for hose barb fittings and vinyl or urethane hose.

[See Page 185.](#)

Assembly Services

Call Clippard for assistance with your application, assembly and testing. Clippard can provide full tested sub-assemblies for your application or device. For more information call Clippard today.



Clippard's Unique Electronic "Mouse" Valves

Clippard's Electronic Valves are quiet and quick! Valves accept low voltage, low current signals, convert them into high pressure (100 psig) pneumatic outputs. Optional low pressure/medium flow and low pressure/high flow are available.

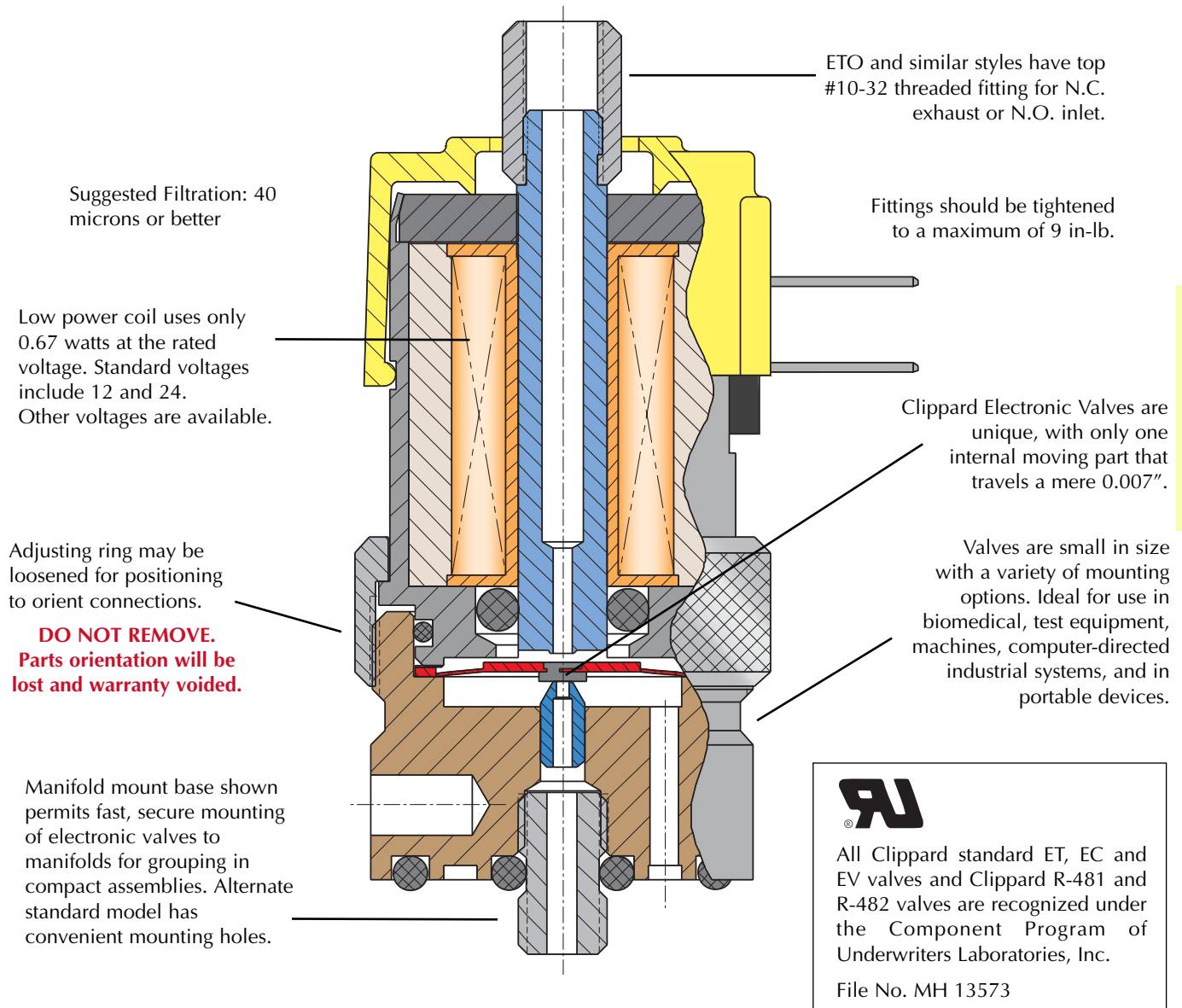

Clippard Minimatic electronic valves are precision-built 2-way or 3-way control valves, utilizing a unique, patented, valving principle. There are no sliding parts. Complete poppet travel is a mere 0.007". As a result, low power consumption and exceptionally long life are major benefits of this design.

The valves are very quiet in operation and also very cool. The valves' small size makes them well suited to a wide range of applications in biomedical, environmental test equipment, textile machines, packaging machinery, computerized industrial automation, and portable systems.



THE MOUSE VALVE SERIES

Clippard Functional Simplicity

- The design of Clippard electronic valves is a deceptively simple arrangement with a minimum of operating parts, and remarkably straight forward low power operation.
- The Clippard "spider" is the only moving part and its motion to operate the valve is a mere 0.007" travel.
- Low voltage D.C. inputs, signals from simple manual switching up to computer directed systems, move the spider in extremely fast response time . . . 5 to 10 milliseconds.
- The unit uses extremely low power (0.67 watts at the rated voltage) and is cool running. The valves are light in weight, compact in physical size and mount easily in space-saving packages.



Quick Connect

Clippard ET valves feature spade lugs for simple, quick secure low voltage connections. Wire crimp-on spade lug connectors are available separately to adapt electronic wiring where necessary. Clippard original EV type valves are available in popular voltages with 18" wire leads. The EC model utilizes a 0.025" square pin connector.



Easy Mounting

The complete line of EC, EV, ET and EW electronic valves are available with two mounting options. Standard base models have two 6-32 threaded, 7/32" deep mounting holes. Manifold models are equipped with a bottom stud, 5/32" long with #10-32 thread, which fits Clippard standard and special manifolds, accessory valves and subplates. Spanner holes in the valve body permit tightening.

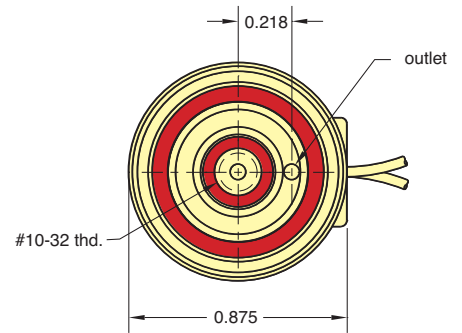

CUSTOM SOLUTIONS

If you need a product that fits your application perfectly, Clippard has the capability to design or modify one of its products to suit your exact needs. We understand that a standard catalog product may be close but not be exactly what you need. Let us know YOUR need, and we will help to find YOUR Solution!

CUSTOMer solutions



Clippard's Electronic Valves are incredibly flexible from a production standpoint. Just let us know what you need.

- Custom Voltage
- Custom Flow Rate
- Custom Max Pressure/ Vacuum

Tight Assemblies Cartridge design is desirable for integrating valves into compact assemblies. This EVP proportional valve is calibrated to meet the customers flow range and maintain "zero" leak rate, and is incorporated into the OEM's manifold.



Clippard Integrated Solutions offer optimized pneumatic system design to increase performance, reduce cost, and make your job easier.



MOUSE VALVE SERIES DESCRIPTIONS



Standard Series

2- and 3-way manifold and in-line mounting. Normally-Closed and fully-ported versions.

Higher Flow 2-Way Version. The standard series also includes an option that provides higher flow for 2-way, Normally-Closed applications. Although manifold mounting is accomplished in the same fashion, the inlet is the annular port, and the outlet becomes the center port, through the convenient stud mount of the valve.

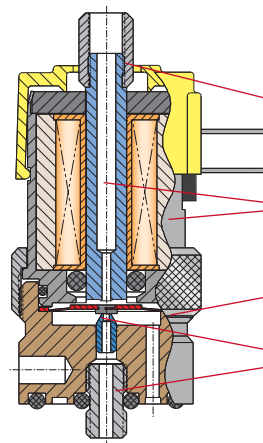

- Nickel-plated brass fitting
- Electroless nickel-plated steel housing and core
- Buna-N seals standard
- Electroless nickel-plated brass body
- Stainless steel stud and nozzle
- (Manifold style valve shown)



Corrosion-Resistant "CR-" Series

Clippard's Corrosion-Resistant Series (CR-) incorporates materials and construction that provides enhanced protection for valves used with mildly corrosive media such as moisture in air or gases. Where stainless steel is not possible, plating is incorporated to add life to wear components. A nickel-plated brass valve body is standard, but stainless steel may be substituted.

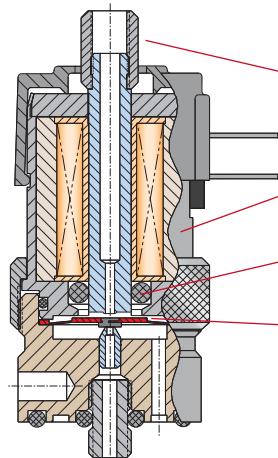

- Nickel-plated brass fitting
- Stainless steel housing and core
- Buna-N seals standard
- Electroless nickel-plated Spider



NEW! Analytical "A-" Series

Clippard's Electronic Analytical Valve (A-) series combines the proven features of the "Mouse" series with the specific needs of the analytical industry, and for applications where cleanliness is especially important. Special materials, manufacturing and assembly processes make this valve perfectly suited for applications where internal cleanliness, bubble-tight operation, and long life are imperative.

For more information, visit clippard.com/analytical

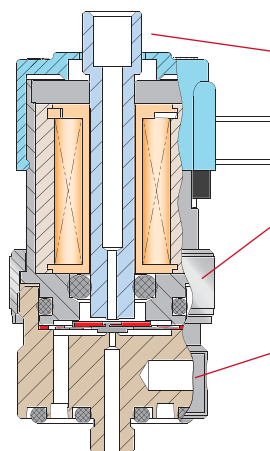

- Integral fitting
- No anaerobic sealant used
- Larger cross section O-ring improves sealing
- Cleaned per Clippard Standard ES-3.43
- One-piece base eliminates many leak points



MOUSE VALVE SERIES DESCRIPTIONS



Oxygen Clean "O-" Series

All EV, ET, EC and EW series electronic valves with the "O-" part number option are available manufactured and assembled for use in Oxygen-enriched environments for applications that are extremely sensitive to contamination.

- Valves are ultrasonically cleaned, assembled, inspected and tested in an enclosed controlled area with a state-of-the-art positive pressure HEPA filtration system
- Both organic and inorganic contaminants such as particulate matter and Hydrocarbon oils are removed
- No organic sealants, adhesives or lubricants are used in the manufacturing process
- Component parts are lubricated with Oxygen-compatible PFPE (perfluoropoly ether) grease, only as needed for assembly
- Individual testing and inspection is accomplished utilizing compressed Nitrogen and ultra-violet light

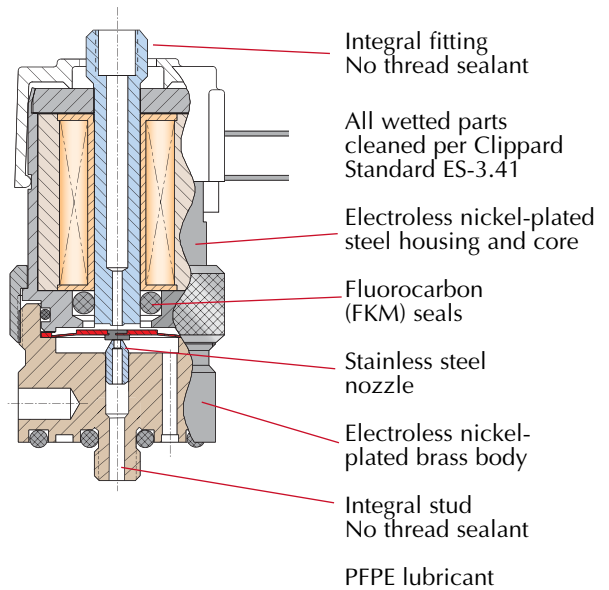

For more information on the process, visit www.clippard.com/oxygen

ECN, EVN, ETN Mouse Valves

Normally-Open, manifold mount to allow Normally-Closed and Normally-Open valves on the same manifold. See [page 181](#) for ordering information.

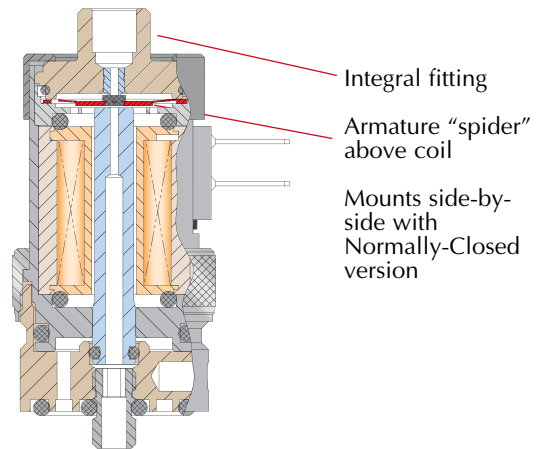

Custom EV Valves

Don't see it here? Call us! Many people shy away from asking for customized products and fear increased price and lead times. Clippard's electronic valve production consist of nealy 50% customized product. From the simple tweaks to complex challenges, Clippard is your partner for finding the right solution to your needs.



Electrical Connection Options

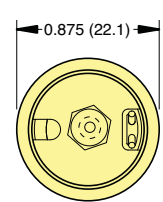
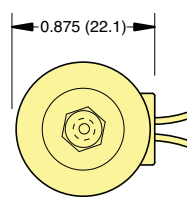
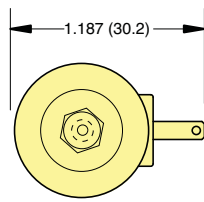
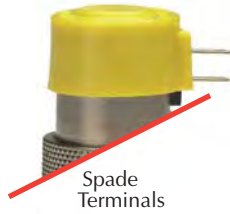
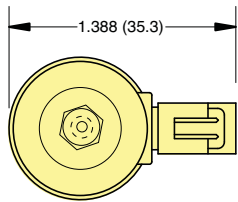

Valve Types

In-Line Mount

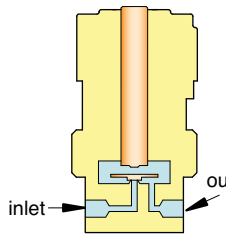

2-Way Normally-Closed In-Line Mount

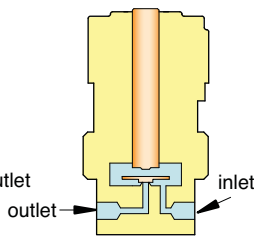

2-Way Normally-Closed High Flow In-Line Mount

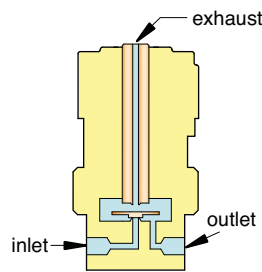

3-Way Normally-Closed In-Line Mount

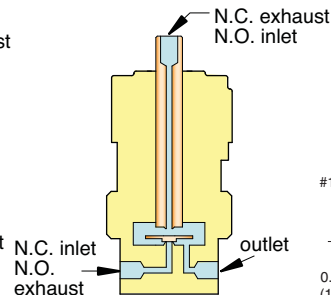

3-Way Fully-Ported In-Line Mount

Mounting Options

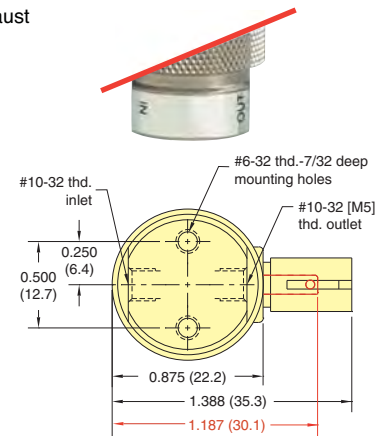

Manifold Mount

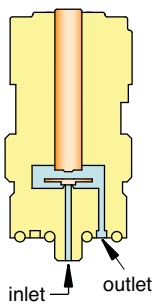

2-Way Normally-Closed Manifold Mount

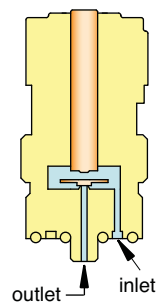

2-Way Normally-Closed High Flow Manifold Mount

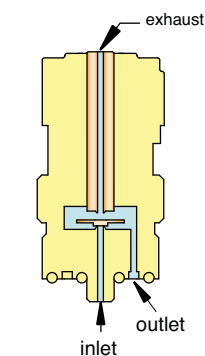

3-Way Normally-Closed Manifold Mount

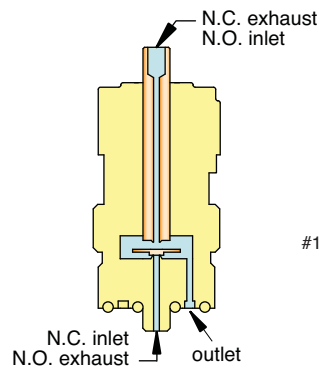

3-Way Fully-Ported Manifold Mount

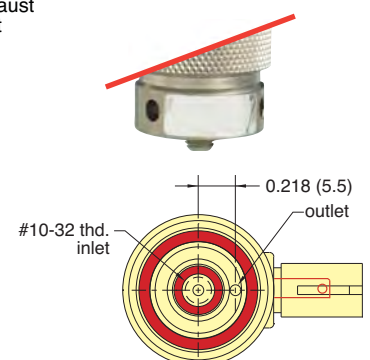



GAS FLOW & ELECTRICAL SPECIFICATIONS

Typical Air Flow

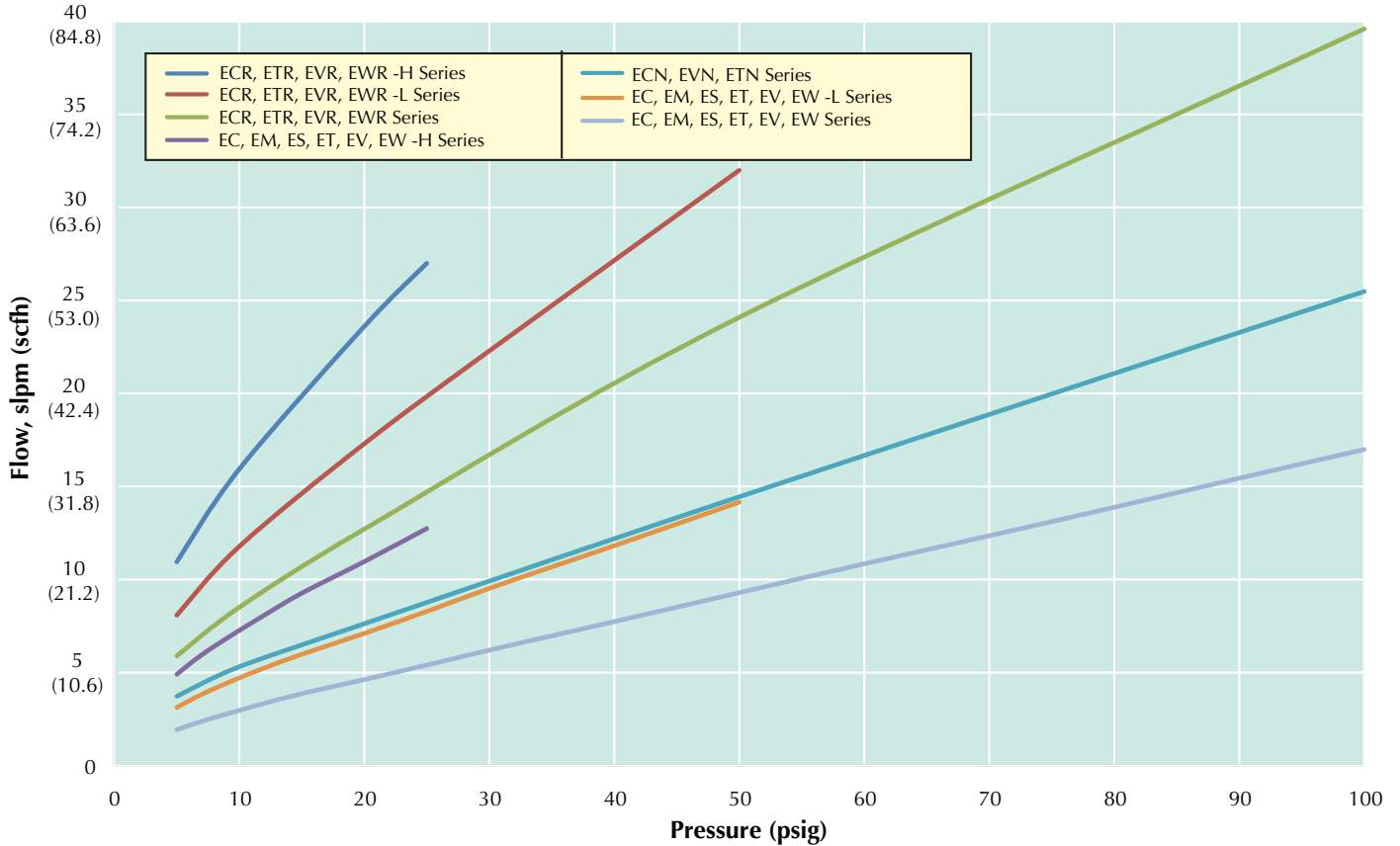

Electrical Specifications

Series	Nominal			Power (watts)	Working Range (cont. duty)
	Voltage	Current (amps)	Resistance (ohms)		
<u>- Standard</u> <u>- Oxygen Clean</u> <u>- Analytical</u>	6	0.11	54	0.67	90 to 150% of rated voltage
	12	0.055	218		
	24	0.028	864		
<u>- Corrosion-Resistant</u>	12	0.098	122	1.2	90 to 110% of rated voltage
	24	0.049	486		
<u>- EM Series</u> <u>- ES Series</u>	12	0.083	144	1.0	90 to 120% of rated voltage
	24	0.042	576		

2-WAY NORMALLY-CLOSED VALVES, IN-LINE & MANIFOLD MOUNT

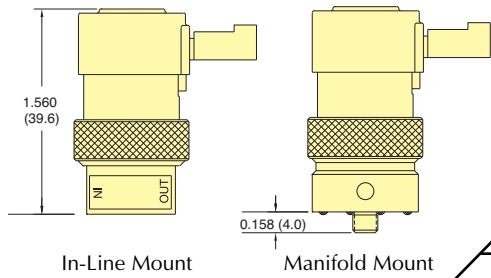

In-Line Mount	Manifold Mount	Pressure Range		Voltage		Part No.	
		Vac. to 105 psig +	Vac. to 50 psig	Vac. to 25 psig	12 VDC	24 VDC	In-Line Mount
		•	•	•	•	* EC-2-12	* EC-2M-12
		•	•	•	•	* EC-2-24	* EC-2M-24
		•	•	•	•	* EC-2-12-L	* EC-2M-12-L
		•	•	•	•	* EC-2-24-L	* EC-2M-24-L
		•	•	•	•	* EC-2-12-H	* EC-2M-12-H
		•	•	•	•	* ET-2-12	* ET-2M-12
		•	•	•	•	* ET-2-24	* ET-2M-24
		•	•	•	•	* ET-2-12-L	* ET-2M-12-L
		•	•	•	•	* ET-2-24-L	* ET-2M-24-L
		•	•	•	•	* ET-2-12-H	* ET-2M-12-H
		•	•	•	•	* EV-2-12	* EV-2M-12
		•	•	•	•	* EV-2-24	* EV-2M-24
		•	•	•	•	* EV-2-12-L	* EV-2M-12-L
		•	•	•	•	* EV-2-24-L	* EV-2M-24-L
		•	•	•	•	* EV-2-12-H	* EV-2M-12-H
		•	•	•	•	* EW-2-12	* EW-2M-12
		•	•	•	•	* EW-2-24	* EW-2M-24
		•	•	•	•	* EW-2-12-L	* EW-2M-12-L
		•	•	•	•	* EW-2-24-L	* EW-2M-24-L
		•	•	•	•	* EW-2-12-H	* EW-2M-12-H

Medium: Clean, dry air (40 micron filter)

Power Consumption: 0.67 watt (CR Series: 1.2 watt)

Temperature Range: 32 to 180°F (0 to 82°C).
CR Series: 32 to 150°F (0 to 64°C)

Response: 5 to 10 milliseconds (nominal)

Operating Range: 90 to 150% of rated voltage (CR Series: ±10%)

Ports: #10-32 (M5 optional), in-line only

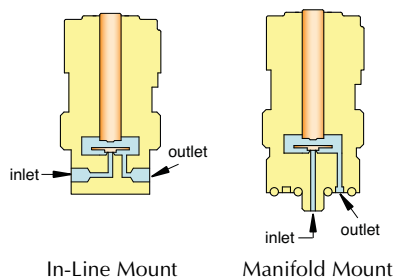

Valve Series (*)	Standard	Non-Standard
Standard	(blank)	
Oxygen Clean	O-	See Pages 173 & 174 for further information
Analytical Series**	A-	
Corrosion-Resistant	CR-	
(not std. on "EW")		
Options (add to end of Part No.)		
FKM Seals	-V	
EPR Seals		-E
Silicone Seals		-S
Diode		-D
Metric Ports (in-line)	-M5	

Pressure Range	Orifice	Air Flow
28" Hg Vac. to 105 psig <i>+ call for special configurations</i>	0.025"	0.6 scfm @ 100 psig (17 l/min @ 7 bar)
28" Hg Vac. to 50 psig	0.040" (-L)	0.5 scfm @ 50 psig (14 l/min @ 3.5 bar)
28" Hg Vac. to 25 psig	0.060" (-H)	0.45 scfm @ 25 psig (13 l/min @ 1.8 bar)

Example Part No's:
ET-2M-12-V
CR-ET-2-12

See [Page 175](#) for mounting options







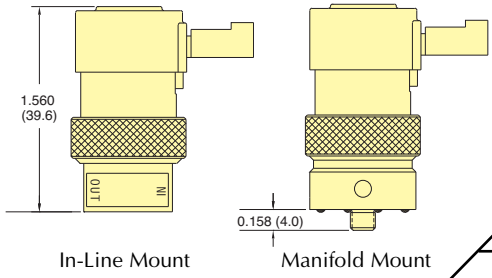

** Available on manifold mount valves only

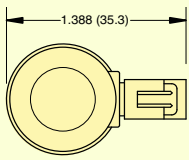

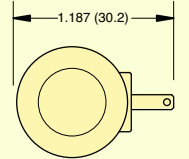
NEW! 2-WAY NORMALLY-CLOSED HIGH FLOW VALVES, IN-LINE & MANIFOLD MOUNT

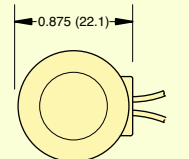

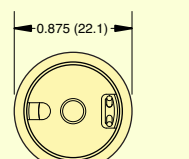
Part No.

		Pressure Range			Voltage		In-Line Mount	Manifold Mount	
		Vac. to 105 psig +	Vac. to 50 psig	Vac. to 25 psig	12 VDC	24 VDC			
 1.388 (35.3)	 0.025" Pin Connector	•			•		* ECR-2-12	* ECR-2M-12	
		•			•		* ECR-2-24	* ECR-2M-24	
			•			•		* ECR-2-12-L	* ECR-2M-12-L
			•			•		* ECR-2-24-L	* ECR-2M-24-L
			•			•		* ECR-2-12-H	* ECR-2M-12-H
	•			•		* ECR-2-24-H	* ECR-2M-24-H		
 1.187 (30.2)	 Spade Terminals	•			•		* ETR-2-12	* ETR-2M-12	
		•			•		* ETR-2-24	* ETR-2M-24	
			•			•		* ETR-2-12-L	* ETR-2M-12-L
			•			•		* ETR-2-24-L	* ETR-2M-24-L
			•			•		* ETR-2-12-H	* ETR-2M-12-H
	•			•		* ETR-2-24-H	* ETR-2M-24-H		
 0.875 (22.1)	 Wire Leads Side (Radial)	•			•		* EVR-2-12	* EVR-2M-12	
		•			•		* EVR-2-24	* EVR-2M-24	
			•			•		* EVR-2-12-L	* EVR-2M-12-L
			•			•		* EVR-2-24-L	* EVR-2M-24-L
			•			•		* EVR-2-12-H	* EVR-2M-12-H
	•			•		* EVR-2-24-H	* EVR-2M-24-H		
 0.875 (22.1)	 Wire Leads Top (Axial)	•			•		* EWR-2-12	* EWR-2M-12	
		•			•		* EWR-2-24	* EWR-2M-24	
			•			•		* EWR-2-12-L	* EWR-2M-12-L
			•			•		* EWR-2-24-L	* EWR-2M-24-L
			•			•		* EWR-2-12-H	* EWR-2M-12-H
	•			•		* EWR-2-24-H	* EWR-2M-24-H		

Medium: Clean, dry air (40 micron filter)

Power Consumption: 1.2 watt

Temperature Range: 32 to 150°F (0 to 66°C)

Response: 10 milliseconds (nominal)

Operating Range: ±10% of rated voltage

Ports: #10-32 (M5 optional), in-line only

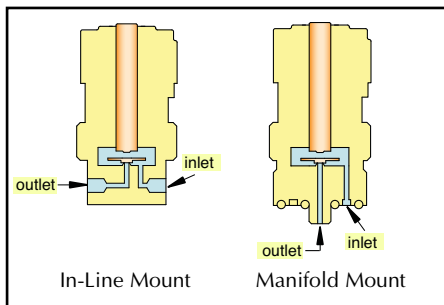

Valve Series (*)	Standard	Non-Standard
Standard	(blank)	See Pages 173 & 174 for further information
Oxygen Clean	O-	
Analytical Series**	A-	
Options (add to end of Part No.)		
FKM Seals	-V	
EPR Seals		-E
Silicone Seals		-S
Diode		-D
Metric Ports (in-line)	-M5	

See Page 175 for mounting options

** Available on manifold mount valves only

Pressure Range	Suffix	Air Flow
28" Hg Vac. to 100 psig <i>+call for special configurations</i>	(blank)	1.4 scfm @ 100 psig (39 l/min @ 7 bar)
28" Hg Vac. to 50 psig	-L	1.1 scfm @ 50 psig (32 l/min @ 3.5 bar)
28" Hg Vac. to 25 psig	-H	0.95 scfm @ 25 psig (27 l/min @ 1.8 bar)

3-WAY NORMALLY-CLOSED VALVES, IN-LINE & MANIFOLD

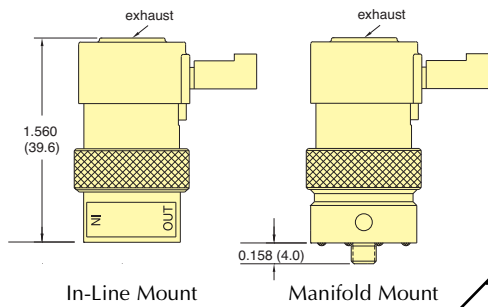

		Pressure Range			Voltage		Part No.	
		Vac. to 105 psig +			Vac. to 50 psig		Vac. to 25 psig	
					12 VDC		24 VDC	
							In-Line Mount	
							Manifold Mount	
 0.025" Pin Connector		•			•		<u>*EC-3-12</u>	<u>*EC-3M-12</u>
		•			•	•	<u>*EC-3-24</u>	<u>*EC-3M-24</u>
			•			•	<u>*EC-3-12-L</u>	<u>*EC-3M-12-L</u>
			•			•	<u>*EC-3-24-L</u>	<u>*EC-3M-24-L</u>
				•		•	<u>*EC-3-12-H</u>	<u>*EC-3M-12-H</u>
			•			•	<u>*EC-3-24-H</u>	<u>*EC-3M-24-H</u>
 Spade Terminals		•			•		<u>*ET-3-12</u>	<u>*ET-3M-12</u>
		•			•	•	<u>*ET-3-24</u>	<u>*ET-3M-24</u>
			•			•	<u>*ET-3-12-L</u>	<u>*ET-3M-12-L</u>
			•			•	<u>*ET-3-24-L</u>	<u>*ET-3M-24-L</u>
				•		•	<u>*ET-3-12-H</u>	<u>*ET-3M-12-H</u>
			•			•	<u>*ET-3-24-H</u>	<u>*ET-3M-24-H</u>
 Wire Leads Side (Radial)		•			•		<u>*EV-3-12</u>	<u>*EV-3M-12</u>
		•			•	•	<u>*EV-3-24</u>	<u>*EV-3M-24</u>
			•			•	<u>*EV-3-12-L</u>	<u>*EV-3M-12-L</u>
			•			•	<u>*EV-3-24-L</u>	<u>*EV-3M-24-L</u>
				•		•	<u>*EV-3-12-H</u>	<u>*EV-3M-12-H</u>
			•			•	<u>*EV-3-24-H</u>	<u>*EV-3M-24-H</u>
 Wire Leads Top (Axial)		•			•		<u>*EW-3-12</u>	<u>*EW-3M-12</u>
		•			•	•	<u>*EW-3-24</u>	<u>*EW-3M-24</u>
			•			•	<u>*EW-3-12-L</u>	<u>*EW-3M-12-L</u>
			•			•	<u>*EW-3-24-L</u>	<u>*EW-3M-24-L</u>
				•		•	<u>*EW-3-12-H</u>	<u>*EW-3M-12-H</u>
			•			•	<u>*EW-3-24-H</u>	<u>*EW-3M-24-H</u>

- Medium:** Clean, dry air (40 micron filter)
- Power Consumption:** 0.67 watt (CR Series: 1.2 watt)
- Temperature Range:** 32 to 180°F (0 to 82°C), CR Series: 32 to 150°F (0 to 64°C)
- Response:** 5 to 10 milliseconds (nominal)
- Operating Range:** 90 to 150% of rated voltage (CR Series: ±10%)
- Ports:** #10-32 (M5 optional), in-line only

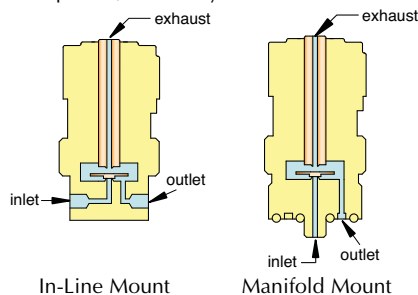

Valve Series (*)	Standard	Non-Standard
Standard	(blank)	
Oxygen Clean	O-	See Pages 173 & 174 for further information
Analytical Series**	A-	
Corrosion-Resistant (not std. on "EW")	CR-	
Options (add to end of Part No.)		
FKM Seals	-V	
EPR Seals		-E
Silicone Seals		-S
Diode		-D
Metric Ports (in-line)	-M5	

Pressure Range	Orifice	Air Flow
28" Hg Vac. to 105 psig <i>*call for special configurations</i>	0.025"	0.6 scfm @ 100 psig (17 l/min @ 7 bar)
28" Hg Vac. to 50 psig	0.040" (-L)	0.5 scfm @ 50 psig (14 l/min @ 3.5 bar)
28" Hg Vac. to 25 psig	0.060" (-H)	0.45 scfm @ 25 psig (13 l/min @ 1.8 bar)

Example Part No's:
ET-3-12-S
O-EW-3-24

See Page 175 for mounting options





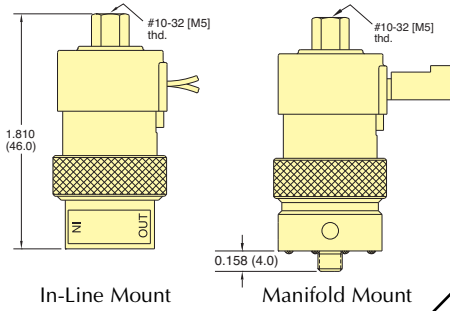

** Available on manifold mount valves only

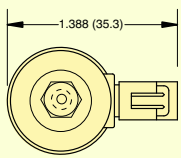

3-WAY FULLY-PORTED VALVES, IN-LINE & MANIFOLD

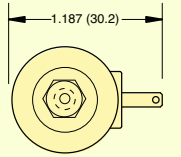
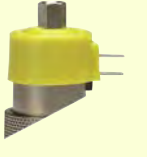
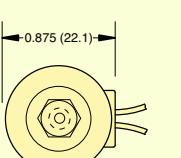

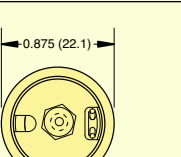
Part No.

		Pressure Range		Voltage		In-Line Mount	Manifold Mount
		Vac. to 105 psig +	Vac. to 50 psig	Vac. to 25 psig	12 VDC	24 VDC	
 0.025" Pin Connector		•	•	•	•	*ECO-3-12	*ECO-3M-12
		•	•	•	•	*ECO-3-24	*ECO-3M-24
		•	•	•	•	*ECO-3-12-L	*ECO-3M-12-L
		•	•	•	•	*ECO-3-24-L	*ECO-3M-24-L
		•	•	•	•	*ECO-3-12-H	*ECO-3M-12-H
 Spade Terminals		•	•	•	•	*ETO-3-12	*ETO-3M-12
		•	•	•	•	*ETO-3-24	*ETO-3M-24
		•	•	•	•	*ETO-3-12-L	*ETO-3M-12-L
		•	•	•	•	*ETO-3-24-L	*ETO-3M-24-L
		•	•	•	•	*ETO-3-12-H	*ETO-3M-12-H
 Wire Leads Side (Radial)		•	•	•	•	*EVO-3-12	*EVO-3M-12
		•	•	•	•	*EVO-3-24	*EVO-3M-24
		•	•	•	•	*EVO-3-12-L	*EVO-3M-12-L
		•	•	•	•	*EVO-3-24-L	*EVO-3M-24-L
		•	•	•	•	*EVO-3-12-H	*EVO-3M-12-H
 Wire Leads Top (Axial)		•	•	•	•	*EWO-3-12	*EWO-3M-12
		•	•	•	•	*EWO-3-24	*EWO-3M-24
		•	•	•	•	*EWO-3-12-L	*EWO-3M-12-L
		•	•	•	•	*EWO-3-24-L	*EWO-3M-24-L
		•	•	•	•	*EWO-3-12-H	*EWO-3M-12-H

Medium: Clean, dry air (40 micron filter)

Power Consumption: 0.67 watt (CR Series: 1.2 watt)

Temperature Range: 32 to 180°F (0 to 82°C)
CR Series: 32 to 150°F (0 to 64°C)

Response: 5 to 10 milliseconds (nominal)

Operating Range: 90 to 150% of rated voltage (CR Series: ±10%)

Ports: #10-32 (M5 optional), in-line only

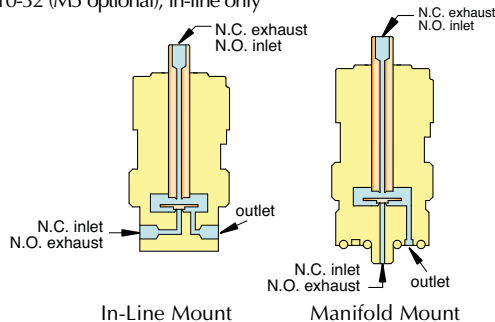

Valve Series (*)	Standard	Non-Standard
Standard	(blank)	
Oxygen Clean	O-	See Pages 173 & 174 for further information
Analytical Series**	A-	
Corrosion-Resistant (not std. on "EWO")	CR-	
Options (add to end of Part No.)		
FKM Seals	-V	
EPR Seals		-E
Silicone Seals		-S
Diode		-D
Metric Ports (in-line)	-M5	

Example Part No's:
ETO-3M-24-D
CR-EVO-3-12





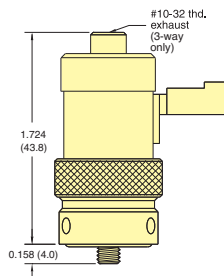

See Page 175 for mounting options

** Available on manifold mount valves only

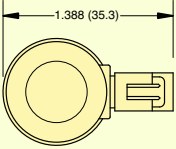
Pressure Range	Orifice	Air Flow
28" Hg Vac. to 105 psig +call for special configurations	0.025"	0.6 scfm @ 100 psig (17 l/min @ 7 bar)
28" Hg Vac. to 50 psig	0.040" (-L)	0.5 scfm @ 50 psig (14 l/min @ 3.5 bar)
28" Hg Vac. to 25 psig	0.060" (-H)	0.45 scfm @ 25 psig (13 l/min @ 1.8 bar)

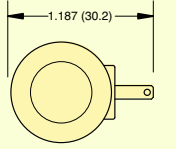
2-WAY & 3-WAY NORMALLY-OPEN VALVES, MANIFOLD

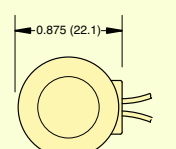

		Voltage		2-Way	3-Way
		12 VDC	24 VDC		
 0.025" Pin Connector		•		<u>ECN-2M-12</u>	* <u>ECN-3M-12</u>
			•	<u>ECN-2M-24</u>	* <u>ECN-3M-24</u>
 Spade Terminals		•		<u>ETN-2M-12</u>	* <u>ETN-3M-12</u>
			•	<u>ETN-2M-24</u>	* <u>ETN-3M-24</u>
 Wire Leads Side (Radial)		•		<u>EVN-2M-12</u>	* <u>EVN-3M-12</u>
			•	<u>EVN-2M-24</u>	* <u>EVN-3M-24</u>

Medium: Clean, dry air (40 micron filter)

Power Consumption: 0.67 watt

Temperature Range: 32 to 180°F (0 to 82°C)

Response: 5 to 10 milliseconds (nominal)

Operating Range: 90 to 150% of rated voltage

Voltage: 12 VDC or 24 VDC. Other voltages available upon request.

Ports: #10-32 (M5 optional)

Options	Standard	Non-Standard
(add to end of Part No.)		
FKM Seals	-V	
EPR Seals		-E
Silicone Seals		-S
Diode		-D
Metric Ports	-M5	

Example Part No's:
EVN-2M-12-V
ETN-3M-24-M5

See [Page 175](#) for mounting options

Pressure Range	Air Flow
28" Hg Vac. to 105 psig *call for special configurations	0.9 scfm @ 100 psig (25 l/min @ 7 bar)

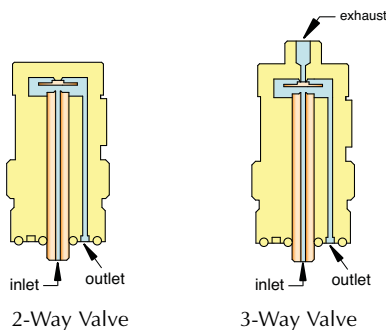



2- & 3-WAY INTRINSICALLY SAFE VALVES

2-WAY INTRINSICALLY SAFE NORMALLY-CLOSED VALVES, IN-LINE & MANIFOLD MOUNT

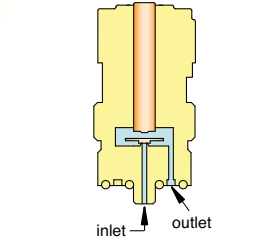
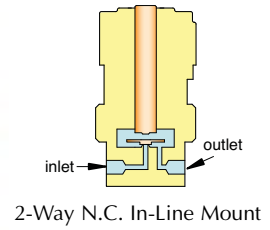
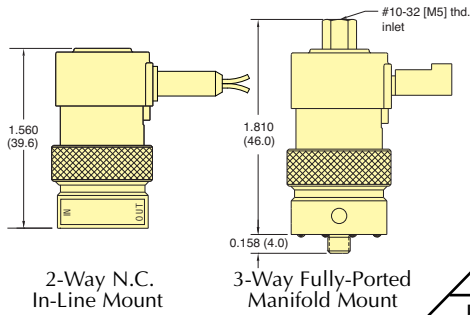

2-Way N.C. Manifold Mount

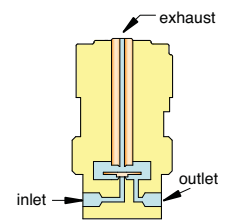

3-Way N.C. In-Line Mount

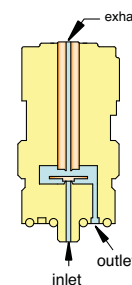

3-Way N.C. Manifold Mount

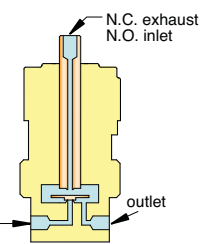

3-Way In-Line Mount

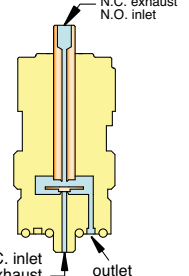

3-Way Manifold Mount

Pressure Range	Part No.	
	In-Line Mount	Manifold Mount
• Vac. to 105 psig + • Vac. to 50 psig • Vac. to 25 psig	•	EI-2-15.5
	•	EI-2-15.5-L
	•	EI-2-15.5-H
•	•	EI-2M-15.5
	•	EI-2M-15.5-L
	•	EI-2M-15.5-H
•	•	EI-2-15.5-C
	•	EI-2-15.5-LC
	•	EI-2-15.5-HC
•	•	EI-2M-15.5-C
	•	EI-2M-15.5-LC
	•	EI-2M-15.5-HC

3-WAY INTRINSICALLY SAFE NORMALLY-CLOSED VALVES, IN-LINE & MANIFOLD MOUNT

Pressure Range	Part No.	
	In-Line Mount	Manifold Mount
•	•	EI-3-15.5
	•	EI-3-15.5-L
	•	EI-3-15.5-H
•	•	EI-3M-15.5
	•	EI-3M-15.5-L
	•	EI-3M-15.5-H
•	•	EI-3-15.5-C
	•	EI-3-15.5-LC
	•	EI-3-15.5-HC
•	•	EI-3M-15.5-C
	•	EI-3M-15.5-LC
	•	EI-3M-15.5-HC

3-WAY INTRINSICALLY SAFE FULLY-PORTED VALVES, IN-LINE & MANIFOLD MOUNT

Pressure Range	Part No.	
	In-Line Mount	Manifold Mount
•	•	EIO-3-15.5
	•	EIO-3-15.5-L
	•	EIO-3-15.5-H
•	•	EIO-3M-15.5
	•	EIO-3M-15.5-L
	•	EIO-3M-15.5-H
•	•	EIO-3-15.5-C
	•	EIO-3-15.5-LC
	•	EIO-3-15.5-HC
•	•	EIO-3M-15.5-C
	•	EIO-3M-15.5-LC
	•	EIO-3M-15.5-HC

- Medium:** Clean, dry air (40 micron filter)
- Power Consumption:** 0.67 watt (CR Series: 1.2 watt)
- Temperature Range:** 32 to 180°F (0 to 82°C)
- Response:** 5 to 10 milliseconds (nominal)
- Operating Range:** 90 to 150% of rated voltage
- Voltage:** 15.5 VDC
- Ports:** #10-32 and manifold mount

See Page 175 for mounting options

Pressure Range	Orifice	Air Flow
28" Hg Vac. to 105 psig <i>+ call for special configurations</i>	0.025"	0.6 scfm @ 100 psig (17 l/min @ 7 bar)
28" Hg Vac. to 50 psig	0.040" (-L)	0.5 scfm @ 50 psig (14 l/min @ 3.5 bar)
28" Hg Vac. to 25 psig	0.060" (-H)	0.45 scfm @ 25 psig (13 l/min @ 1.8 bar)

See www.clippard.com/intrinsicallysafe for more information

EV, ET, EC, EW SERIES HIGHER FLOW VALVES



EC, EV, ET & EW PILOTED 2-WAY & 3-WAY NORMALLY-CLOSED, PRESSURE PILOTED VALVES, MANIFOLD MOUNT

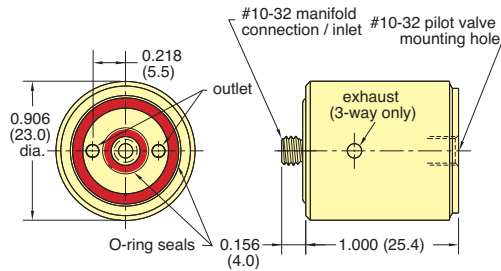

Medium: Air

Materials: Nickel-plated brass, acetal, stainless steel and Buna-N

Response: 20 milliseconds @ 20 psig;
13 milliseconds @ 100 psig nominal

Ports: Inlet and outlet through manifold

Material: Nickel-plated brass, acetal, stainless steel and Buna-N

Note: Use only Normally-Closed 3-Way Pilot valves in conjunction with EVB-2/EVB-3

Part No.

- EVB-2 2-Way Valve Booster
- EVB-3 3-Way Valve Booster

Input Pressure	Air Flow
20 to 150 psig	6.1 scfm @ 100 psig (176 l/min @ 7 bar)

ELECTRONIC INTERFACE 3-WAY NORMALLY-CLOSED VALVE

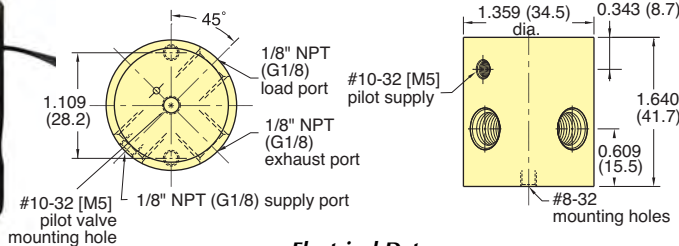

Medium: Air

Filtration: 10 micron

Ports: 1/8" NPT female

Switching Speed: 10 milliseconds

Bleed Flow: 0.10 scfm @ 100 psig

Frequency Response: 50 Hz @ 100 psig;
70 Hz @ 30 psig

Part No.

- 2013-6 Interface Valve, 6 VDC
- 2013-12 Interface Valve, 12 VDC
- 2013-24 Interface Valve, 24 VDC

Continuous Overload: 350% @ 25°C ambient; 250% @ 50°C ambient

Power Consumption: Less than 0.50 watts @ rated voltage (80 ma. @ 6 VDC, 40 ma. @ 12 VDC 20 ma. @ 24VDC)

Leads: 28 gauge stranded PVC insulated

Input Pressure	Air Flow
30 to 100 psig <i>call for special configurations</i>	22 scfm @ 100 psig (634 l/min @ 7 bar)

3-WAY NORMALLY-CLOSED, PRESSURE PILOTED VALVES

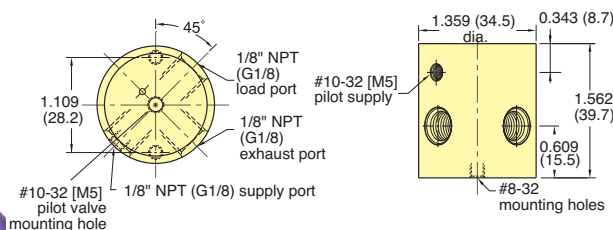

Medium: Air

Pilot Pressure: (2020) 60% of supply pressure, minimum

Response: Approximately 20 milliseconds

Mounting: Mounting holes provided

Ports: Inlet and outlet, exhaust 1/8" NPT
Pilot supply on 2020 is #10-32 female

Materials: Anodized Aluminum, Stainless Steel and Buna-N

Additional Note: Use only Normally-Closed 3-way pilot valves in conjunction with 2020/2021

Option: Add -MG to the end of the Part No. for metric version

Designed to be piloted by a Clippard EC, EV and ET manifold mount electronic valve (not included). Output from the EC, EV and ET actuates the valve to produce outputs up to 22 scfm at 100 psig. Combines low wattage, long life and cool running of the EC, EV and ET valves with quick response and high flow of Clippard "Fluidamp" type valves. The 2020 and 2021 are identical in all respects except one. The 2020 has an external #10-32 pilot port.

Part No.

- 2020 External Piloted Valve with #10-32 Port
- 2021 Internal Piloted Valve

Input Pressure	Air Flow
30 to 100 psig <i>call for special configurations</i>	30 scfm @ 100 psig (2.1 l/min @ 7 bar)



ET PILOTED 4-WAY VALVES & CONNECTORS

4-WAY PILOTED VALVES

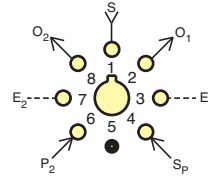
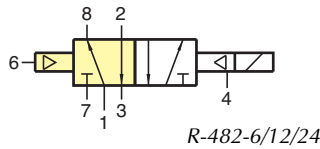
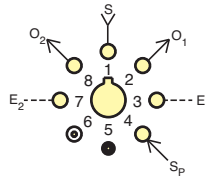
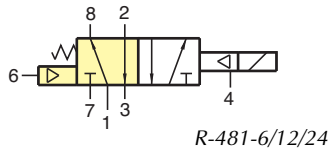

Type: 4-way combination electronic and modular spool type interface valve. Fully-ported ET-3 & R-401 (R-481)/R-402 (R-482) hybrid

Medium: Air, water, or oil; pilot - air only

Mounting: Uses Octoport base and two captivated screws

Ports: Valve has patented Octoport system

Note: Supply pressure must be applied to both ports 1 and 4. Minimum pressure on port 4 should be 40 psig.

Part No.

- R-481-12 ET-3/R-401, 12 VDC
- R-481-24 ET-3/R-401, 24 VDC
- R-482-12 ET-3/R-402, 12 VDC
- R-482-24 ET-3/R-402, 24 VDC

Input Pressure	Air Flow
Pilot: 40 psig min.	9 scfm @ 100 psig
Working: 0 to 150 psig	(255 l/min @ 7 bar)

For more information please see [Page 270](#) in the Modular Valve section of this catalog.

ET VALVE CONNECTORS

Black molded lug connectors are available for easy push-on connection ET-C48 is 48" in length, ET-C120 is 120" in length.



Insulated crimp-on spade lug connectors are available for wiring up leads to connect an electronic circuit to ET style valves. Accepts #22, #24, or #26 wire.



Part No.

- ET-C48 48" Connector
- ET-C120 120" Connector

Part No.

- 3831 Spade Lug Connector

EC & EI VALVE CONNECTORS

TE Connectivity #5-103956-1 with 18" or 120" wire leads for EC/ECO and EI/EIO valves.

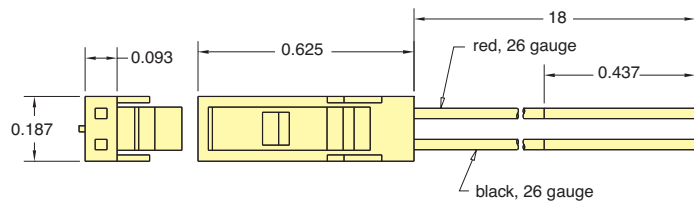

Part No.

- C2-RB18 18" Connector
- C2-RB120 120" Connector



CUSTOM PORTS & CONNECTORS

If you need a product that fits your application perfectly, Clippard has the capability to design or modify one of its products to suit your exact needs.

This application requires a special connection to a MAPP gas canister. The valve is tested for response time and flow rate, which delivers a consistent amount of gas each cycle.

CUSTOMer
solutions



Specialized Manifolds

Material: ENP brass
Option: Add -MR for metric version

15490-1 Standard
O-15490-1 Oxygen Clean
 #10-32 [M5] Inlet
 1/8" NPT (R1/8) Outlet

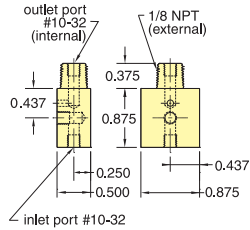

15490-2 Standard
O-15490-2 Oxygen Clean
 1/8" NPT (R1/8) Inlet
 #10-32 [M5] Outlet

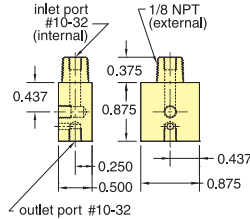

Dual Outlet
15490-3 Standard
O-15490-3 Oxygen Clean
 1/8" NPT (R1/8) Inlet
 #10-32 [M5] Outlet

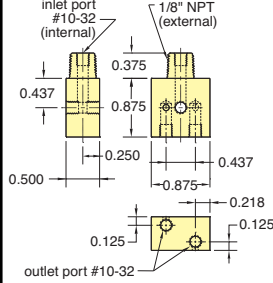

15491-1 Standard
O-15491-1 Oxygen Clean
 #10-32 [M5] Inlet
 1/8" NPT (R1/8) Outlet

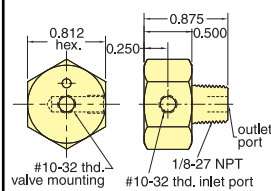

15491-2 Standard
O-15491-2 Oxygen Clean
 1/8" NPT (R1/8) Inlet
 #10-32 [M5] Outlet

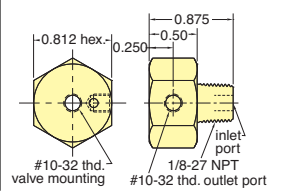

Use: Mount EV, ET, EC, and EW valves to any 1/8" NPT supply port

Oxygen Clean Manifolds

Multi-station manifolds are available for use with Clippard's Oxygen Clean series electronic valves. These manifolds offer either single-sided or double-side mounting in Oxygen-compatible ENP brass material.

The Oxygen series products are manufactured and assembled for applications in Oxygen-enriched environments which are extremely sensitive to contamination. Each manifold is cleaned according to [Clippard Specification #ES-3.41](#), and double bagged in heat-sealed polyethylene bags.



- Input Ports:** In-line 1/8" NPT (G1/8 optional)
- Outlet Ports:** #10-32 (M5 optional)
- Mounting:** #10-32 tapped holes (M5 optional)
- Materials:** ENP Brass
- Option:** Add -M5 for Metric version

Single-Sided		Double-Sided		"A"	Length "L"	Mtg. "M"
Part No.	Stations	Part No.	Stations			
O-15581-2*	2	O-15582-8*	8	0.444	1.826	0.937
O-15581-4*	4	O-15582-8*	8	0.913	3.702	1.875
O-15581-6*	6	O-15582-12*	12	0.913	5.577	3.750

* Add -M5 for metric version (G1/8 inlet)

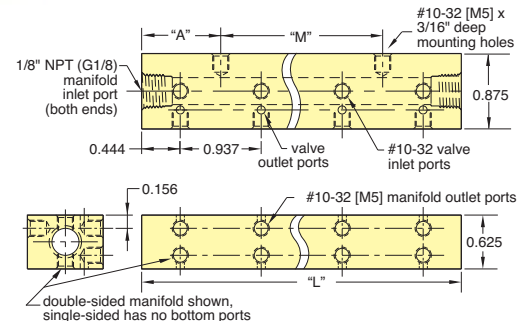

Multi-Valve Manifolds

Construction: Black anodized aluminum
Option: Add -M5 for Metric version



Single-Sided		Double-Sided		"A"	Length "L"	Mtg. "M"
Part No.	Stations	Part No.	Stations			
15481-2	2	15482-8	8	0.444	1.826	0.937
15481-4	4	15482-8	8	0.913	3.702	1.875
15481-6	6	15482-12	12	0.913	5.577	3.750

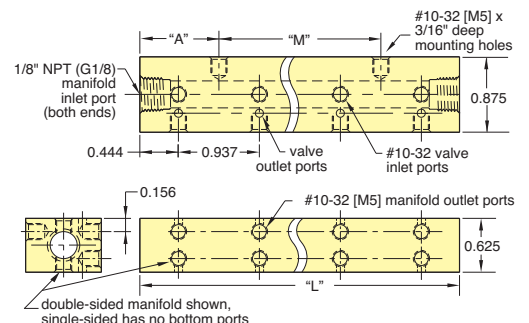



ELECTRONIC MANIFOLD CARD

Auxiliary Power Input

Power to operate the valves may be provided through two sources: ONE, through the 25-pin connector if your signal source also has sufficient power to operate the bank of valves, or TWO, through a separate auxiliary power input connection built into the board. To isolate power from the 25-pin connector, use the power source selector switch.

NOTE: In applying power on a temporary basis, use care to observe proper circuit polarity.

Reverse Polarity Protection

Circuit using diodes and capacitor provides input voltage protection against reverse polarity.

Resistor-Diode-LED Circuit

Individual circuit to each valve provides protection against shut-off spikes. LED is illuminated when valve is actuated.

Printed Circuit Board

Durable laminated fiberglass

3-Position Detented Switches

Three position slide switch provides for: ON - Power "ON"; valve is activated; OFF - Power "OFF"; valve not connected; CONN - Valve connected to 25-pin connector, and will be controlled through it.

Power Selector Switch

Two-position selector switch enables choice of power input source (25-pin connector or auxiliary).

25-Pin Connector

Clippard Electronic Valves

Clippard Valve Manifold

Compact, efficient mounting of the valves is by Clippard multi-valve manifolds.

LED Bank

Illuminated LED signals that the valve is actuated.

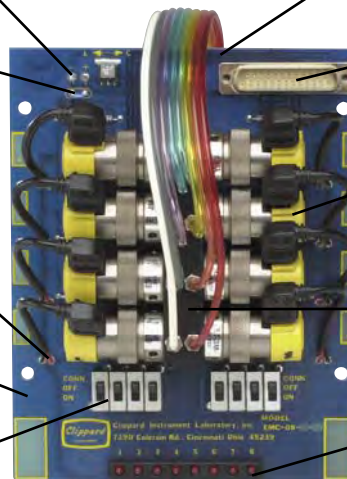

Clippard Electronic Manifold Cards

Now you can direct low-voltage DC signals from controllers, systems, computers or other sources to operate powerful pneumatic valves with a minimum of piping and hook-up.

Self-contained card includes:

- 8 or 12 Clippard ET interface valves
- Manifold mount for single air supply
- Circuit board fully wired
- Instant plug-in with 25-pin connector
- Resistor, diode, LED and switch for each valve
- Auxiliary power supply connection

Ready to operate quickly. Just mount the card and make external connection. And each valve may be individually removed and replaced without any need for desoldering!

Convenience in interfacing electronics and pneumatics . . . completely assembled, manifolded valve cards.

Features

- Fast, easy to mount
- Pre-assembled; all valves mounted
- Low power requirements (0.67 watt per valve)
- Choice of valve types
- Each valve switchable
- Shut-off spike protection
- 25-pin connector
- No expensive card rack required

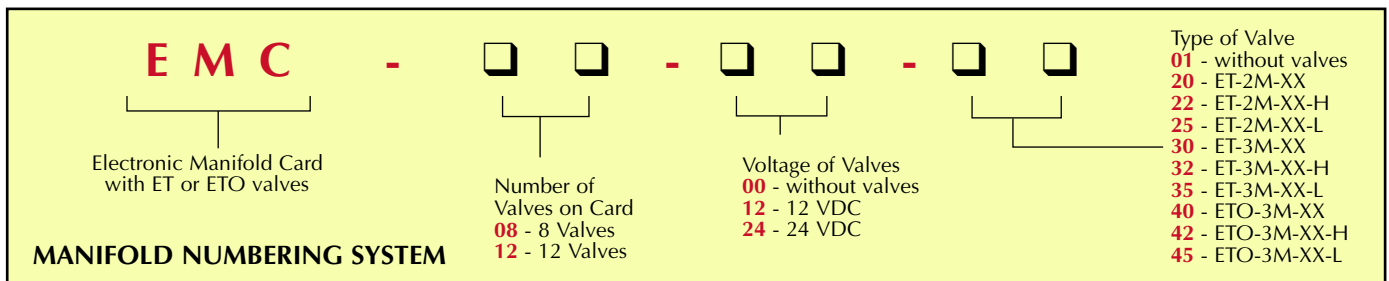

EMC-08-00-01 and EMC-12-00-01 are part numbers for cards without any valves, and without manifold. Manifold mounting hardware is included. Manifolds may be ordered separately, if desired. Part numbers are: 15482-8 and 15482-12.

EMC-08

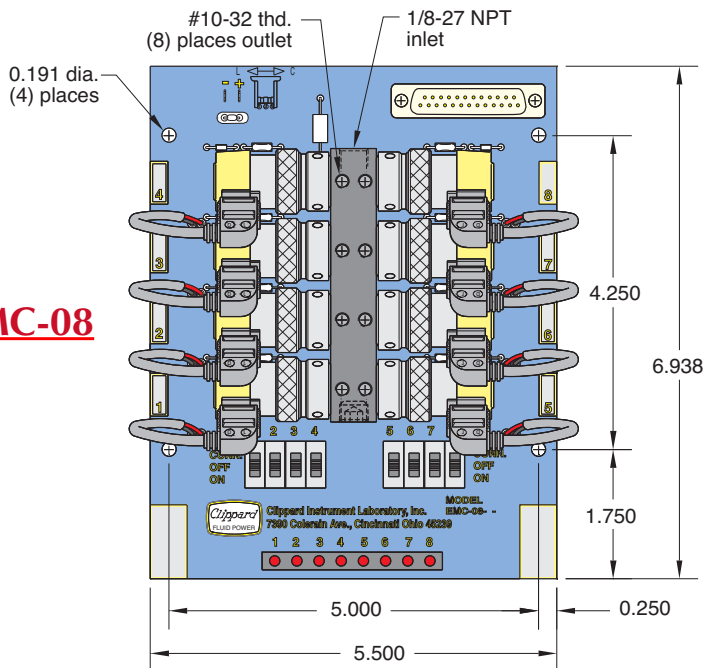

EMC-12

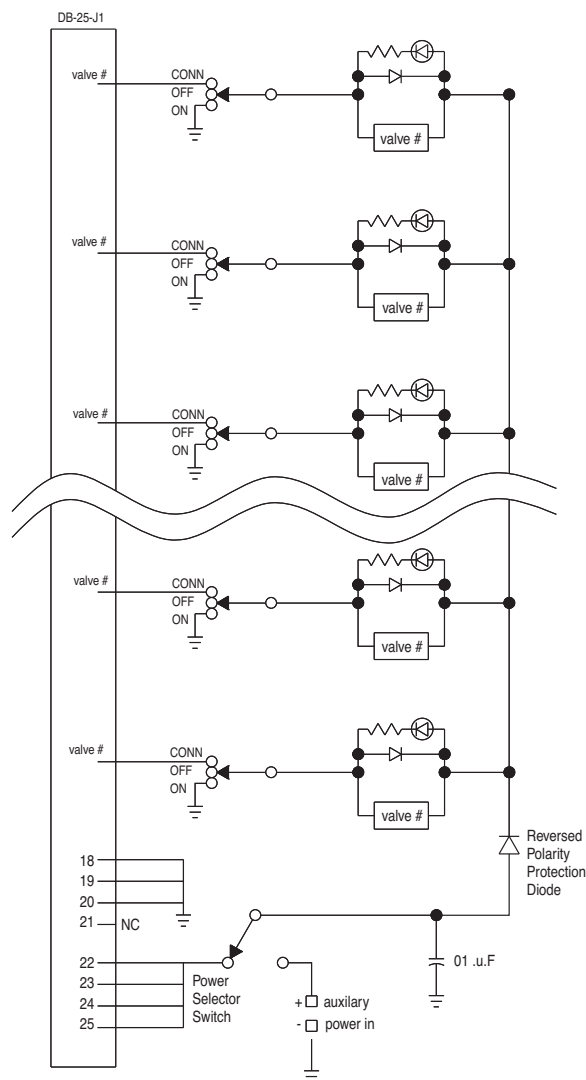
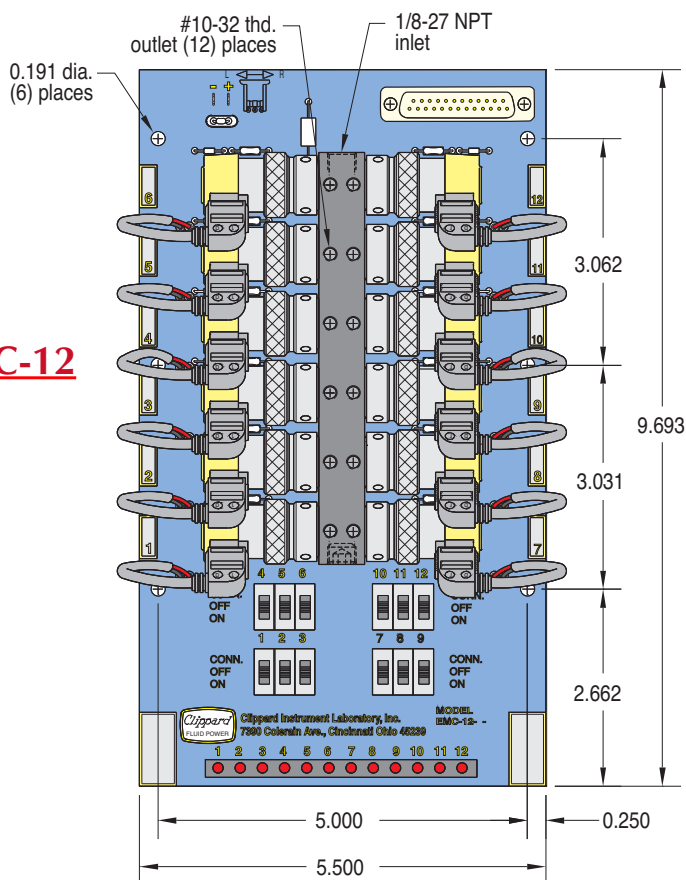

Wiring Diagram

Note: Manifold mounted valves are Normally-Closed. Use ETO models if exhaust must be ported. ETO models cannot be used "Normally-Open" without special piping.



EVP SERIES PROPORTIONAL CONTROL VALVES

The EVP series Proportional Control Valves combine the features of the existing EV series valve - long life, low power, and Clippard's reputation for high quality components - with the additional capability for proportional control.

The EVP series valve provides air or gas flow control, and varies the output flow based on the current input to the solenoid. The consistent gain (see chart) of this valve provides a high degree of control for many applications.

Controllability and overall value are the main features of the EVP Proportional Valve series. The valve may be controlled using DC current, open or closed-loop control, and even PWM (Pulse Width Modulation) to cover a broad range of applications.

Features

- Flow proportional to input current
- Fast response
- Long life
- Small package
- Single moving part - low friction and wear
- Five orifice sizes
- Three connection styles
- Two mounting types

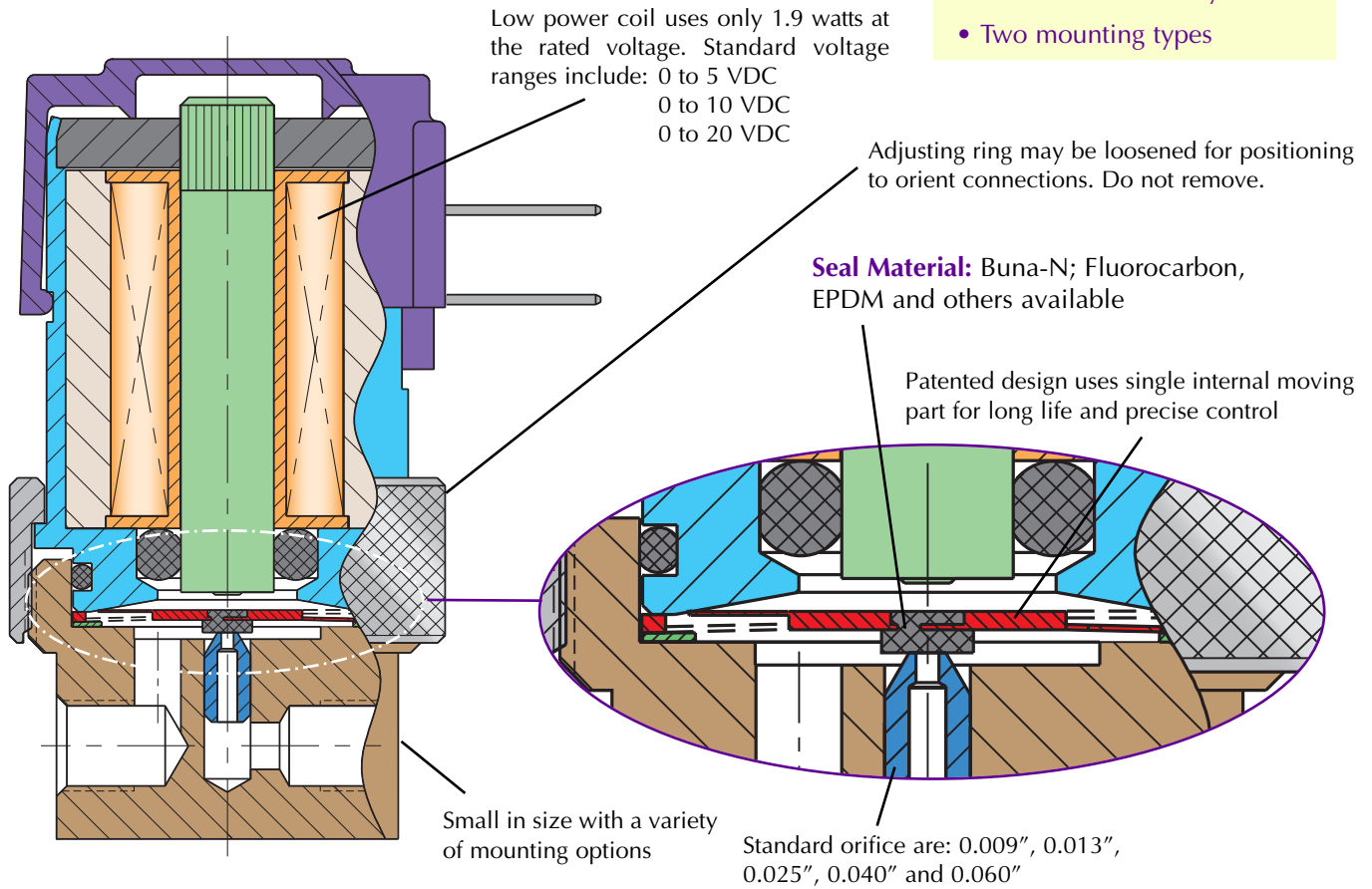

Designed For:

- Analytical Instruments
- Blood pressure monitoring
- Precise pressure control
- Patient Simulators
- Automotive
- Gas Controllers
- Mass Flow Control
- Gas Chromatography
- Respirators / Ventilators and many more...

EVP SERIES PROPORTIONAL CONTROL VALVES



Based on Clippard's original spider design from 1973, the EVP's armature is the heart of the valve which provides precise flow control.

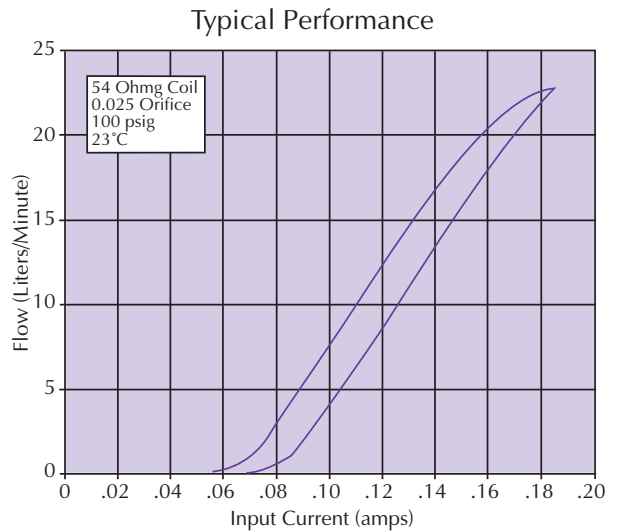

Type: 2-Way, Proportional

Medium: Air, Inert Gases

Temperature Range: 32 to 120°F (0 to 49°C)

Power Consumption: 1.9 watts at 23°C, 2.3 watts max

Mounting: In-line or Manifold (see [page 185](#) for manifolds)

Ports: #10-32 Female (In-line)

#10-32 Male Stud (Manifold)

Seal Material: Buna-N; Fluorocarbon and EPDM
Others available.

Maximum Hysteresis: 10% of full current

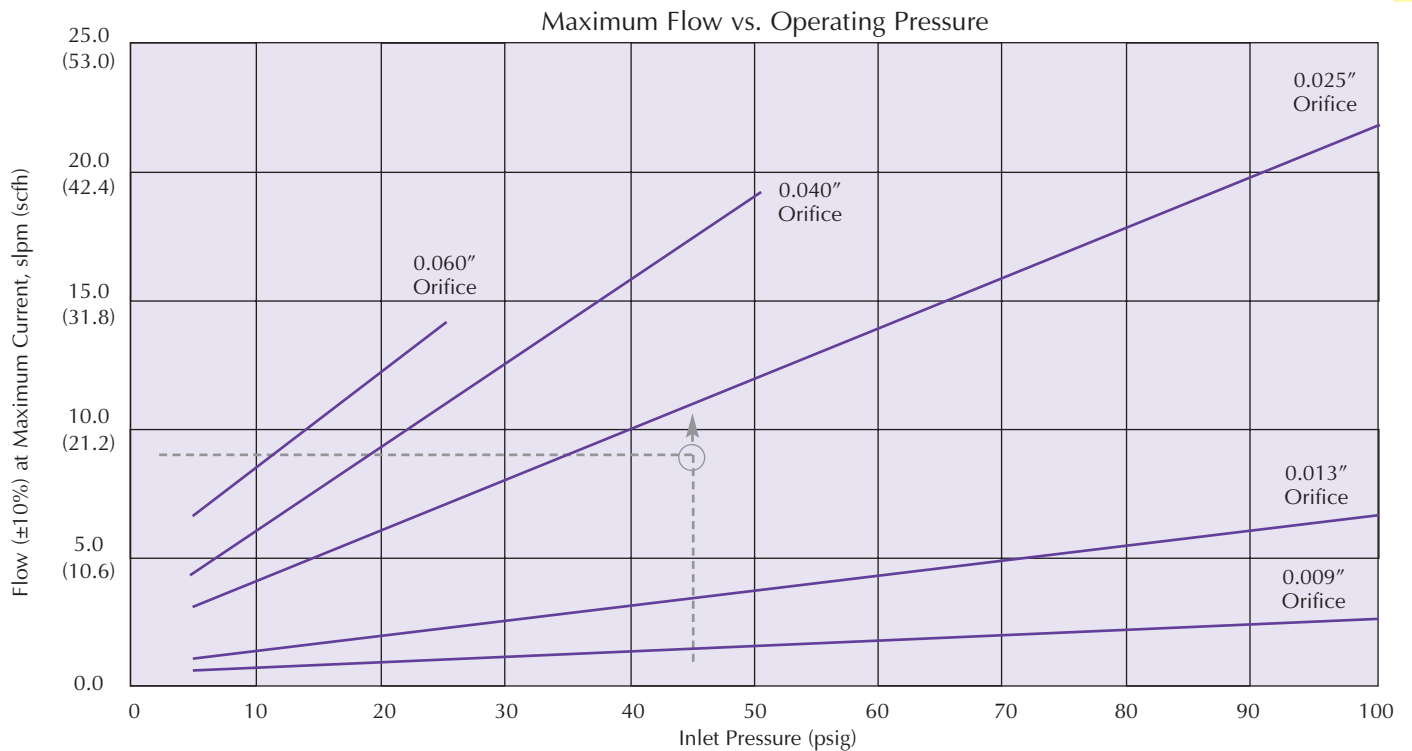

To determine the correct orifice required, locate the colored line immediately above the flow/pressure intersection
Example: 9 slpm required at 45 psig inlet. This example leads to a "-2545" valve (0.025" nozzle, 45 psig).



2-WAY PROPORTIONAL VALVES, IN-LINE & MANIFOLD MOUNT

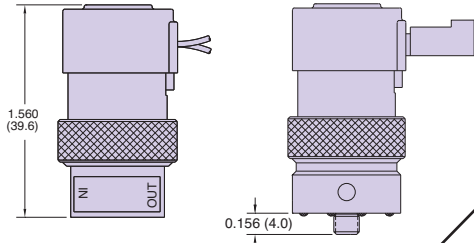

		Voltage			Base Part No.		Operating Range & Orifice
		5 VDC	10 VDC	20 VDC	In-Line Mount	Manifold Mount	
	<p>0.025" Pin Connector</p>	•			<u>EC-P-05-*</u>	<u>EC-PM-05-*</u>	<p>* Complete Part Number with the number derived after choosing the desired Maximum Operating Range and Orifice size below.</p>
		•	•		<u>EC-P-10-*</u>	<u>EC-PM-10-*</u>	
			•	•	<u>EC-P-20-*</u>	<u>EC-PM-20-*</u>	
	<p>Spade Terminals</p>	•			<u>ET-P-05-*</u>	<u>ET-PM-05-*</u>	
		•	•		<u>ET-P-10-*</u>	<u>ET-PM-10-*</u>	
			•	•	<u>ET-P-20-*</u>	<u>ET-PM-20-*</u>	
	<p>Wire Leads Side (Radial)</p>	•			<u>EV-P-05-*</u>	<u>EV-PM-05-*</u>	
		•	•		<u>EV-P-10-*</u>	<u>EV-PM-10-*</u>	
			•	•	<u>EV-P-20-*</u>	<u>EV-PM-20-*</u>	

Base Part No. plus [] [] - [] - [] []

See Page 189 for flow chart/selection

Orifice Options:

- 09 - 0.009" dia.
- 13 - 0.013" dia.
- 25 - 0.025" dia.
- 40 - 0.040" dia.
- 60 - 0.060" dia.

Maximum Pressure (specify Operating Pressure):

- [] - 5 to 100 psig
- [] - 5 to 50 psig
- [] - 5 to 25 psig

Options:
Blank - none
E - EPDM seals
V - FKM seals

Ports:
Blank - #10-32
M5 - Metric

* Consult factory for availability of non-standard voltages and other options

Sample part number: EC-P-10-2585

Medium: Clean, dry air or inert gases

Power Consumption: 1.9 watts at 73°F, 2.3 watts max

Temperature Range: 32 to 120°F (0 to 49°C)

Ports: #10-32 Female (in-line); manifold (see page 185 for manifold options)

Nominal Voltage Range @ 73°F (VDC)	Input Current Range (amps)	Coil Resistance @ 73°F (ohms)	Max. Voltage Required (VDC)
0 to 5	0 to 0.370	13.5	6.2
0 to 10	0 to 0.185	54	12.4
0 to 20	0 to 0.092	218	24.8

Do not exceed input current range.

The EVP Proportional Valve can be calibrated for pressures less than the maximum shown here. Lower pressures may be substituted, and will be used for calibration. The pressures shown above are standard options. For pressures less than 5 psig, please consult factory.

NEW! EVPD PROPORTIONAL VALVE DRIVER



Features

- Plug-and-play interface between Clippard's EVP series valves and PLCs or other controls
- Linearized valve response right "out of the box"
- Three selectable valve output ranges
- Five signal inputs to choose from
- Easy integration with existing machine controls
- User-adjustable parameters
- Automatic Temperature Compensation to maintain constant current
- Two configuration options: stand-alone PCB or enclosed in housing
- Compact size.

Plug-and-Play Control for Proportional Valves

The New EVPD Proportional Valve Driver fast-tracks valve-control applications. This product is ideal for laboratories and OEM product development, and can be customized to fit OEM applications including control parameters. The EVPD produces driver current for Clippard's EVP series valves proportional to input control signals.

Power Requirement: 7 to 28 VDC @ 5 Watt (see chart)

Input Impedance: 200 kΩ

Command Set-Point Signal Type: Selectable: 0 to 5 VDC, 0 to 10 VDC, 0 to 20 mA, 4 to 20 mA, PWM @ ≥2 kHz duty cycle

Adjustments: Minimum Drive Current, Maximum Drive Current, Command Deadband

LED Indicators: Power; Activity Status & Faults

Output: 0 to 0.4 A (selectable range)

Temperature Range: 0° to 155°F (-18° to 68°C)

Size: Open card: 1.5" x 1.3" x 0.4" unmounted; Enclosed: 2.2" x 1.8" x 0.7" excluding DIN clip

RoHS Compliant

Power Requirements

Power input requirements are specified as supply voltage ranges for each EVP valve. Supplying voltages outside of these ranges may result in valve malfunctioning. Power requirements are determined by the valve voltage specification.

EVP Valve Type	Input Voltage Range	EVPD Max Output*
0 to 5 VDC	7 to 12 VDC	400 mA
0 to 10 VDC	12 to 28 VDC	200 mA
0 to 20 VDC	14 to 28 VDC	100 mA

* See EVP Valve Current Requirements

Part No.	Description
<u>EVPD-2</u>	EVPD Driver Assembly in Enclosure
<u>EVPD-1</u>	EVPD Driver Board
<u>EVPD-2DIN</u>	DIN Rail Mounting Clip (shown at right) with Screws



For further information, visit www.clippard.com/evpd

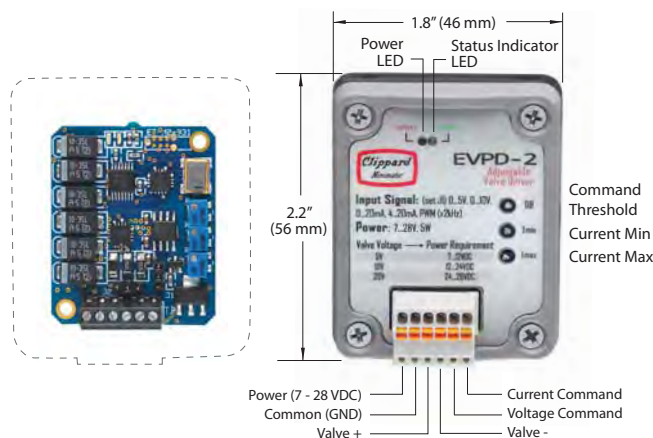

Effect on Valve Flow

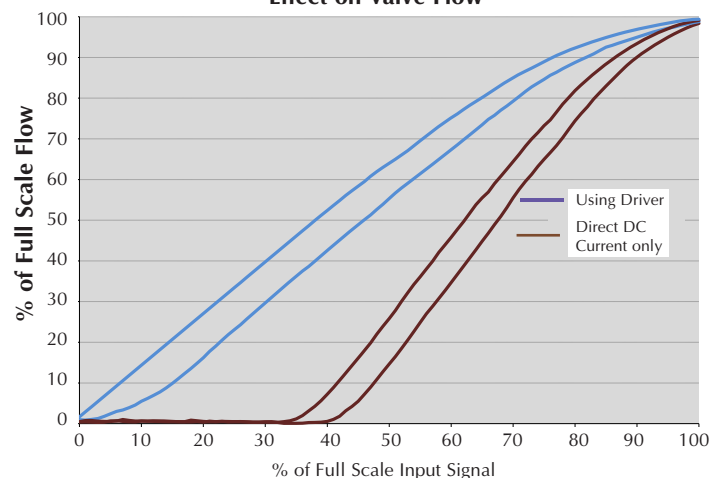
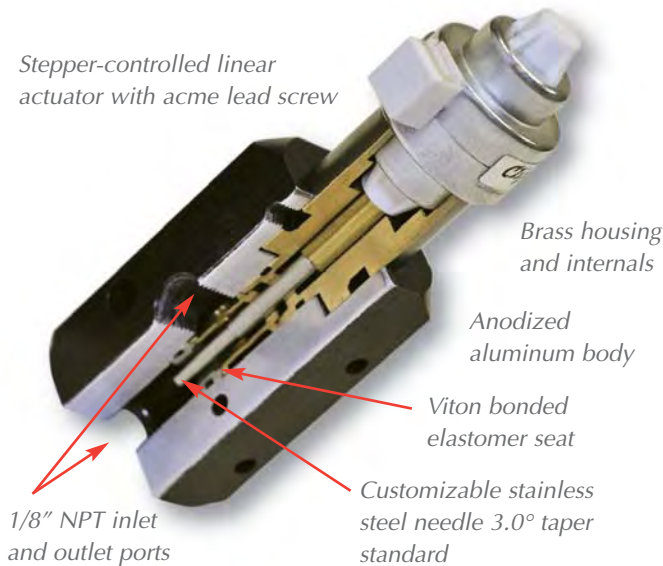

Figure 1: Effect of Driver Output on EVP Flow



NEW! 2-WAY STEPPER-CONTROLLED PROPORTIONAL VALVE

Stepper-controlled linear actuator with acme lead screw



Utilizing the industry's most robust and powerful linear actuator, the high-flow stepper-controlled proportional valve outperforms the competition in performance and durability.

The bonded elastomeric seat achieves excellent sealing ensuring smooth opening and fine control at low flow for millions of cycles.

This valve is ideal in critical applications such as gas delivery, medical, analytical, and industrial automation requiring high resolution, high flow, and low hysteresis. In addition, the unique design allows for custom flow profiles when required.

Features

- 2% hysteresis
- Excellent Linearity — 2.5% of full-scale
- 2 ms reaction time
- Millions of cycles
- Holds position for power savings or at loss of power

Medium: Compatible gases and liquids

Configuration: 1 1/8" square body with 1/8" NPT ports

Typical Cycle Time for Full Travel: 0.95 seconds at 100% duty cycle; 0.55 seconds at 25% duty cycle (full open to full close or full close to full open)

Wetted Material: Stainless steel, aluminum, brass, and FKM*

Pressure Range: Vac to 100 psig (Vac to 7 bar)*

Flow Range: 0 to 300 slpm*

Flow Resolution: 0.56 slpm per step

Position Resolution: 0.001" per step

Temperature Range: 32 to 184°F (0 to 84°C)

Driver: Bipolar chopper drive required

Supply Voltage: 12 to 40 VDC (40 VDC optional)

Response Time: 0.95 sec. fully-open to fully-closed*

Mounting: In-line

Power Consumption: 3.85 watts nominal only during adjustment. Zero power consumption to maintain position.

Ports: 1/8" NPT. Others available upon request.

Seals: FKM standard. Others available.

* This product is highly modifiable for OEM applications including alternate body materials, flow profiles, cartridge styles, manifold mounting, etc. Please consult factory.

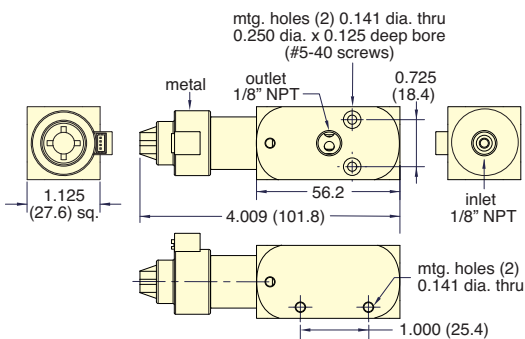

Characteristic Curve

Flow Rate for SCPV-1-3 @ 100 psig

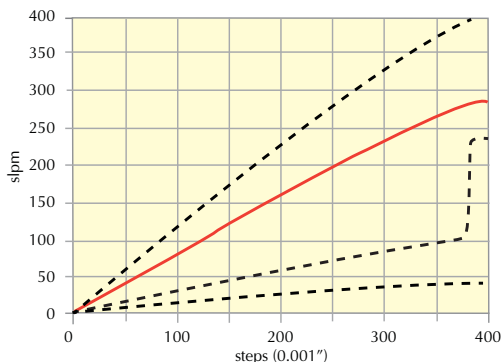

Part No.	Description
SCPV-1-3	Proportional Valve, 3° Needle

For further information, visit www.clippard.com/scpv

NEW! 2-WAY STEPPER-CONTROLLED PROPORTIONAL VALVE



Control Data

A **Bipolar Chopper Drive** (not included) is a power-efficient method of using current to drive a stepping motor to obtain high stepping rates. The chopper gets its name from the technique of rapidly turning the output voltage on and off (chopping) to control motor current.

Stepper motors require some external electrical components in order to operate. These components typically include a power supply, logic sequencer switching components and a clock pulse source to determine the step rate. Many commercially available drives have integrated these components into a complete package. See www.clippard.com/scpv for more information.

Wiring Harness (included)

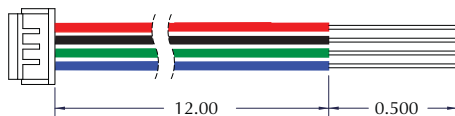

Pin	Color	Pin	Color
1	Red (A+)	3	Green (B-)
2	Black (A-)	4	Blue (B+)

Salient Characteristics Linear Actuator

Wiring:	Bipolar
Current/Phase:	385 mA
Motor Voltage:	5 VDC
Resistance/Phase:	13 W
Inductance/Phase:	8.08 mH
Power Consumption:	3.85 Watts
Rotor Inertia:	1.07 gcm ²
Temperature Rise:	135°F (75°C)
Insulation Resistance:	20M ohms

Maximum Step Pulse Frequency vs. Operating Pressure

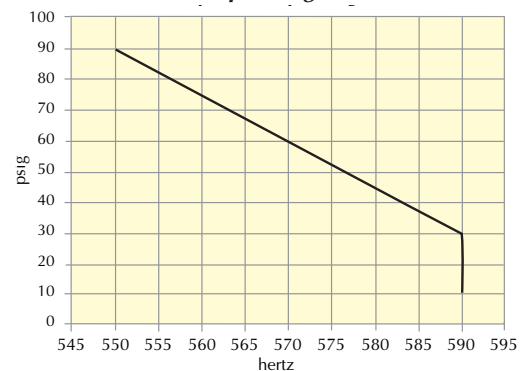

Potential Applications

- Medical/Analytical/Industrial Gas Mixing
- Anesthesia Equipment
- Precision Flow Control
- Cuff/Bladder Pressure Control
- Process Flow Control
- Variable Speed Control
- Automation of Needle Valve

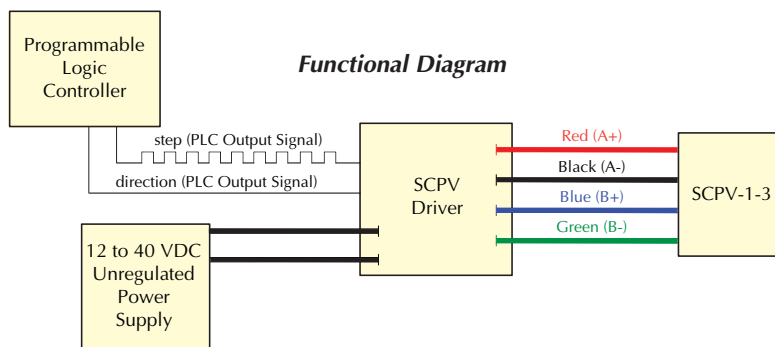

For helpful information and video, visit www.clippard.com/scpv





EM STUD MOUNT 2-WAY & 3-WAY VALVES

2- & 3-WAY NORMALLY-CLOSED & 3-WAY N.O./N.C. VALVES, MANIFOLD MOUNT

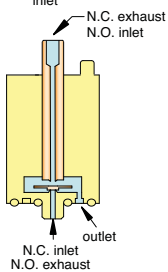
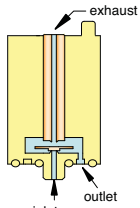
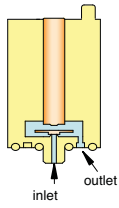
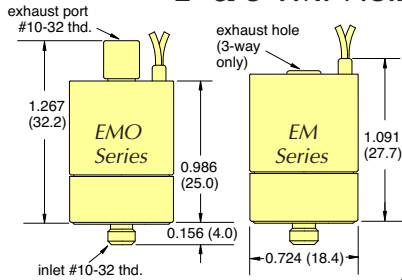

Part No.	Pressure Range			Voltage		2-Way N.C.	3-Way N.C.	3-Way N.O./N.C.
	Vac. to 105 psig +	Vac. to 50 psig	Vac. to 25 psig	12 VDC	24 VDC			
EM-2-12 EM-2-24 EM-2-12-L EM-2-24-L EM-2-12-H EM-2-24-H	•	•		•	•			
EM-3-12 EM-3-24 EM-3-12-L EM-3-24-L EM-3-12-H EM-3-24-H	•	•		•	•			
EMO-3-12 EMO-3-24 EMO-3-12-L EMO-3-24-L EMO-3-12-H EMO-3-24-H	•	•		•	•			

Options (add to end of Part No.)	Standard	Non-Standard
FKM Seals	-V	
EPDM Seals		-E
Silicone Seals		-S
Metric Ports	-M5	

Pressure Range	Orifice	Air Flow
28" Hg Vac. to 105 psig <i>+call for special configurations</i>	0.025"	0.6 scfm @ 100 psig (17 l/min @ 7 bar)
28" Hg Vac. to 50 psig	0.040" (-L)	0.5 scfm @ 50 psig (14 l/min @ 3.5 bar)
28" Hg Vac. to 25 psig	0.060" (-H)	0.45 scfm @ 25 psig (13 l/min @ 1.8 bar)

An even smaller Mouse valve! When space is critical, the EM Series Valve provides the best solution. At just over an inch tall, and less than 3/4" in diameter, the EM Valve uses Clippard's special "spider" design. This reliable and proven design for long life is housed in a miniature body, and incorporates wire leads out the top, allowing body rotation for close-center mounting. In addition, the valve features higher flow; combining fast shifting speed, extremely high cycle life with the design flexibility to make this valve a "small wonder" for demanding applications.

This valve is perfect for air and/or gas control, pilot control, and any application where space is limited, but desired performance is not.

- Medium:** Clean, dry air (40 micron filter)
- Power Consumption:** 1 watt
- Temperature Range:** 32 to 150°F (0 to 82°C)
- Response:** 10 milliseconds at nominal voltage (15 milliseconds N.O.)
- Operating Range:** 90 to 120% of rated voltage
- Voltage:** 12 VDC or 24 VDC. Other voltages available upon request.
- Ports:** #10-32 Exhaust (M5 optional)

Simply tighten valves onto the manifold using a standard 1/8" Allen hex wrench. (4-10 in-lbs. Do not over-tighten)

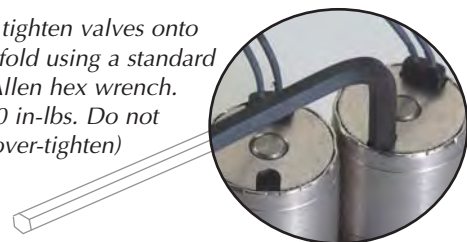

EM STUD MOUNT VALVE MANIFOLDS



EM Series Manifolds

Construction: Black anodized aluminum

Option: Add -M5 for Metric version



Part No.	Stations	Part No.	Stations	Length "L"	Mtg. "M"	"A"
<i>Single-Sided</i>		<i>Double-Sided</i>				
15681-2	2	15682-4	4	1.480"	0.740"	0.370"
15681-4	4	15682-8	8	2.960"	1.480"	0.740"
15681-6	6	15682-12	12	4.440"	2.960"	0.740"
15681-8	8	15682-16	16	5.920"	4.440"	0.740"

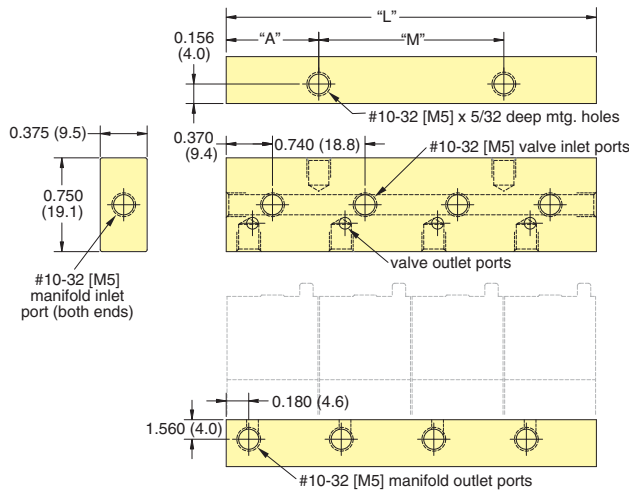

Single-Sided

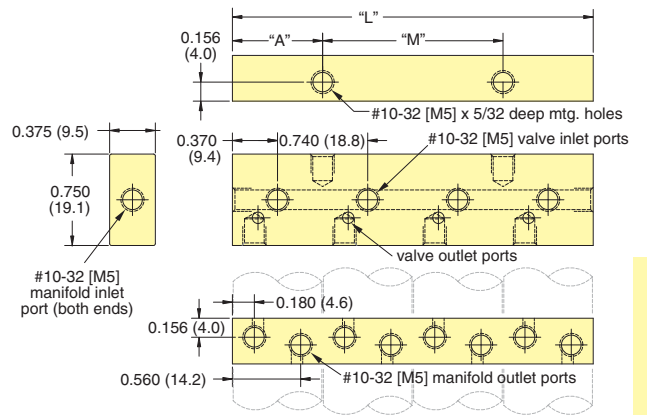

Double-Sided



Manifold Assemblies

Our Value Added department provides assembly services for all Clippard components. If you have a need for special or standard manifolds, and would like to receive a single part number with all components assembled and tested, just contact Clippard. We provide application assistance, special testing, kitting of parts, control boxes, manifold assemblies, and more. Let our experience and capabilities work for you.



ES, ESO SERIES VALVES

Valves are small in size with a variety of coil voltages and flow options. Mounting is as close as 7/8" on center.

Housing is molded Zytel® ST 801 for toughness and rigidity.

Valves feature low power, cool running, quiet operation and fast response time. They convert low voltage, low current signals into high pressure pneumatic outputs.

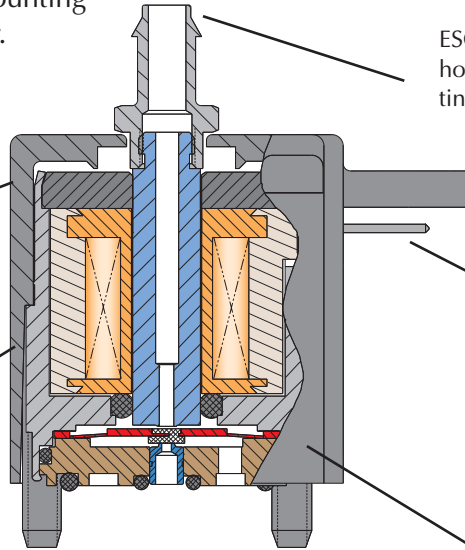

ESO and similar styles have top hose barb or #10-32 threaded fitting for N.C. exhaust or N.O. inlet.

Coils are available to mate with TE Connectivity #5-103956-2 with connector or with 18" wire leads which utilize #26 wire.

Clippard ES valves are unique, with only one internal moving part that travels a mere 0.007".

Quality Design

The compact ES valve, like Clippard EV and ET valves, converts low voltage, low current signals into high pressure (0 to 105 psig) pneumatic outputs, utilizing a unique, patented valving principle. Since there are no sliding parts, and complete poppet travel is only 0.007", low power consumption and exceptionally long life are assured with this design. No flow is required for cooling because the compact ES is cool, as well as quiet, in operation.

The compact nature of design makes this valve well suited to a wide range of applications in biomedical, environmental test equipment, textile machines, packaging machinery, computerized industrial automation, and portable systems.



Features

- Close mounting - 7/8" on center
- Overall height less than 1"
- Easy to mount on manifold with two #4-40 screws
- Geometric design
- Polymer housing - Zytel ST 801® super tough
- TE Connectivity-style pin connection or 18" wire leads
- Flow up to 0.6 scfm (17 l/min)

Zytel ST 801® super tough and Zytel® are a registered trademark of DuPont

NOMINAL			Power (watts)	Working Range (cont. duty)
Voltage*	Current (amps)	Resistance (ohms)		
12	0.083	144	1.0	90 to 120% of rated voltage
24	0.042	576	1.0	

*Other voltages available. Please consult factory.

ES SERIES 2- & 3-WAY NORMALLY-CLOSED VALVES

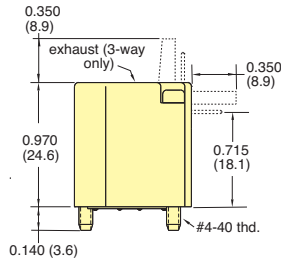

		Pressure Range		Voltage		Part No.	
		Vac. to 105 psig ⁺		Vac. to 50 psig		2-Way	
				12 VDC		3-Way	
				24 VDC			
 Side Pin Connector	•		•	•	ES-2S-12	ES-3S-12	
	•		•	•	ES-2S-24	ES-3S-24	
	•	•	•	•	ES-2S-12-L	ES-3S-12-L	
	•		•	•	ES-2S-24-L	ES-3S-24-L	
		•	•	•	ES-2S-12-H	ES-3S-12-H	
		•	•	•	ES-2S-24-H	ES-3S-24-H	
 Top Pin Connector	•		•	•	ES-2T-12	ES-3T-12	
	•		•	•	ES-2T-24	ET-3T-24	
	•	•	•	•	ES-2T-12-L	ES-3T-12-L	
	•		•	•	ES-2T-24-L	ES-3T-24-L	
		•	•	•	ES-2T-12-H	ES-3T-12-H	
		•	•	•	ES-2T-24-H	ES-3T-24-H	
 Wire Leads Side (Radial)	•		•	•	ES-2W-12	ES-3W-12	
	•		•	•	ES-2W-24	ES-3W-24	
	•	•	•	•	ES-2W-12-L	ES-3W-12-L	
	•		•	•	ES-2W-24-L	ES-3W-24-L	
		•	•	•	ES-2W-12-H	ES-3W-12-H	
		•	•	•	ES-2W-24-H	ES-3W-24-H	
 Board Mount	•		•	•	ES-2B-12	ES-3B-12	
	•		•	•	ES-2B-24	ES-3B-24	
	•	•	•	•	ES-2B-12-L	ES-3B-12-L	
	•		•	•	ES-2B-24-L	ES-3B-24-L	
		•	•	•	ES-2B-12-H	ES-3B-12-H	
		•	•	•	ES-2B-24-H	ES-3B-24-H	

Medium: Clean, dry air (40 micron filter)

Power Consumption: 1 watt at rated voltage

Temperature Range: 32 to 150°F (0 to 64°C)

Response: 5 to 10 milliseconds at max rated pressure

Operating Range: 90 to 120% of rated voltage

Ports: Inlet and outlet through manifold; 3-way exhaust through top of valve (3-way only)

Pressure Range	Orifice	Air Flow
28" Hg Vac. to 105 psig <i>+ call for special configurations</i>	0.025"	0.6 scfm @ 100 psig (17 l/min @ 7 bar)
28" Hg Vac. to 50 psig	0.040" (-L)	0.5 scfm @ 50 psig (14 l/min @ 3.5 bar)
28" Hg Vac. to 25 psig	0.060" (-H)	0.45 scfm @ 25 psig (13 l/min @ 1.8 bar)

See page 176 for flow charts.

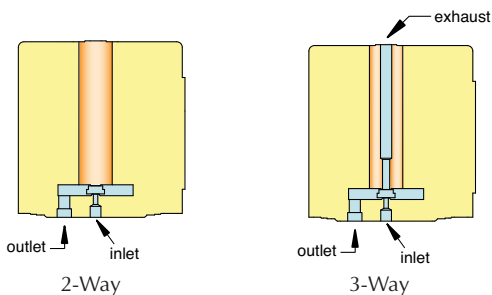



ESO SERIES 3-WAY FULLY-PORTED VALVES

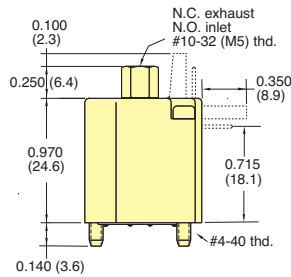

		Pressure Range			Voltage		Part No.
		Vac. to 105 psig +			Vac. to 50 psig		
		Vac. to 25 psig			12 VDC		
		24 VDC					
<p>Side Pin Connector</p>	•			•	•	ESO-3S-12*	
	•			•	•	ESO-3S-24*	
		•		•	•	ESO-3S-12-L*	
		•		•	•	ESO-3S-24-L*	
			•		•	•	ESO-3S-12-H*
			•	•	•	ESO-3S-24-H*	
<p>Top Pin Connector</p>	•			•	•	ESO-3T-12*	
	•			•	•	ETO-3T-24*	
		•		•	•	ESO-3T-12-L*	
		•		•	•	ESO-3T-24-L*	
			•		•	•	ESO-3T-12-H*
			•	•	•	ESO-3T-24-H*	
<p>Wire Leads Side (Radial)</p>	•			•	•	ESO-3W-12*	
	•			•	•	ESO-3W-24*	
		•		•	•	ESO-3W-12-L*	
		•		•	•	ESO-3W-24-L*	
			•		•	•	ESO-3W-12-H*
			•	•	•	ESO-3W-24-H*	
<p>Board Mount</p>	•			•	•	ESO-3B-12*	
	•			•	•	ESO-3B-24*	
		•		•	•	ESO-3B-12-L*	
		•		•	•	ESO-3B-24-L*	
			•		•	•	ESO-3B-12-H*
			•	•	•	ESO-3B-24-H*	

Top Port Options (below)

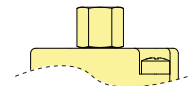

#10-32 (M5)
(standard)

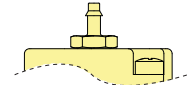

1/16" I.D. Hose Barb
(option "-1")

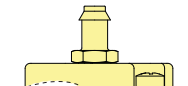

1/8" I.D. Hose Barb
(option "-2")

Medium: Clean, dry air (40 micron filter)

Power Consumption: 1 watt at rated voltage

Temperature Range: 32 to 150°F (0 to 64°C)

Response: 5 to 10 milliseconds at max rated pressure

Operating Range: 90 to 120% of rated voltage

Ports: Normally-Closed: Inlet and outlet through manifold; exhaust through top of valve (#10-32/M5)

Normally-Open: Exhaust and outlet through manifold; inlet through top of valve (#10-32/M5)

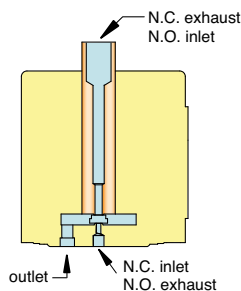

* Options (add to end of Part No.)	Standard
#10-32 Female	(blank)
1/16" I.D. Hose Barb	-1
1/8" I.D. Hose Barb	-2
Metric Ports	-M5

Pressure Range	Orifice	Air Flow
28" Hg Vac. to 105 psig <i>+call for special configurations</i>	0.025"	0.6 scfm @ 100 psig (17 l/min @ 7 bar)
28" Hg Vac. to 50 psig	0.040" (-L)	0.5 scfm @ 50 psig (14 l/min @ 3.5 bar)
28" Hg Vac. to 25 psig	0.060" (-H)	0.45 scfm @ 25 psig (13 l/min @ 1.8 bar)

See page 176 for flow charts.

For Cable and Connectors, see Page 184.



Single-Sided Dual Mount Manifold

Part No.	Description
26081-□	Single-Sided Manifold

Suffix	Valves	L	M1	M2
-4	4	4.375"	2.875"	4.000"
-4-M5	4	111.1 mm	73.0 mm	101.6 mm
-6	6	6.125"	4.625"	5.750"
-6-M5	6	155.6 mm	117.5 mm	146.1 mm
-8	8	7.875"	6.375"	7.500"
-8-M5	8	200.0 mm	161.9 mm	190.5 mm

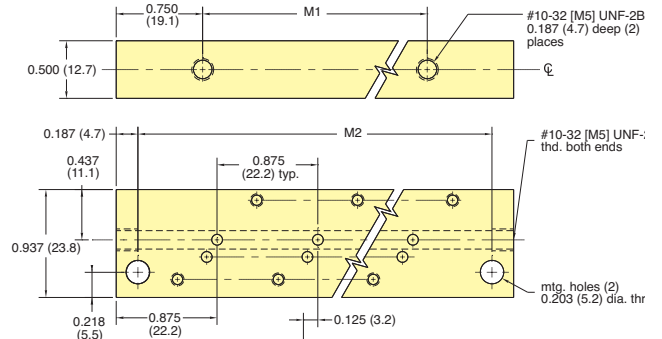

Double-Sided Dual Mount Manifold

Part No.	Description
26082-□	Double-Sided Manifold

Suffix	Valves	L	M1	M2
-8	8	4.375"	2.875"	4.000"
-8-M5	8	111.1 mm	73.0 mm	101.6 mm
-12	12	6.125"	4.625"	5.750"
-12-M5	12	155.6 mm	117.5 mm	146.1 mm
-16	16	7.875"	6.375"	7.500"
-16-M5	16	200.0 mm	161.9 mm	190.5 mm

* ESM-CP plate is to cover individual unused manifold station.

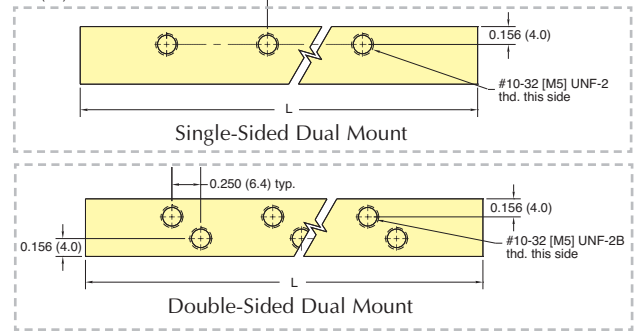

Single-Sided Rear Mount Manifold

Part No.	Description
26083-□	Single-Sided Manifold

Suffix	Valves	L	M
-4	4	3.500"	2.875"
		88.9 mm	73.0 mm
-6	6	5.250"	4.625"
		133.4 mm	117.5 mm
-8	8	7.000"	6.375"
		177.8 mm	161.9 mm

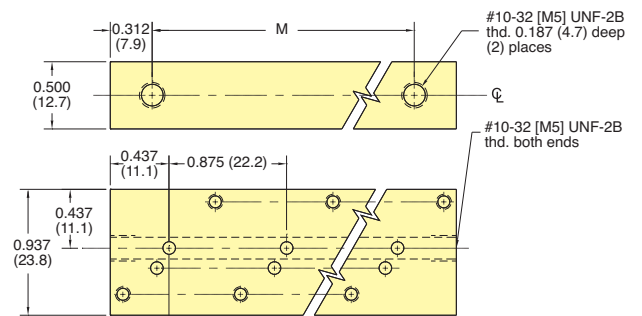

Double-Sided Rear Mount Manifold

Part No.	Description
26084-□	Double-Sided Manifold

Suffix	Valves	L	M
-8	8	3.500"	2.875"
-8-M5	8	88.9 mm	73.0 mm
-12	12	5.250"	4.625"
-12-M5	12	133.4 mm	117.5 mm
-16	16	7.000"	6.375"
-16-M5	16	177.8 mm	161.9 mm

* ESM-CP cover plate is available for one manifold station.

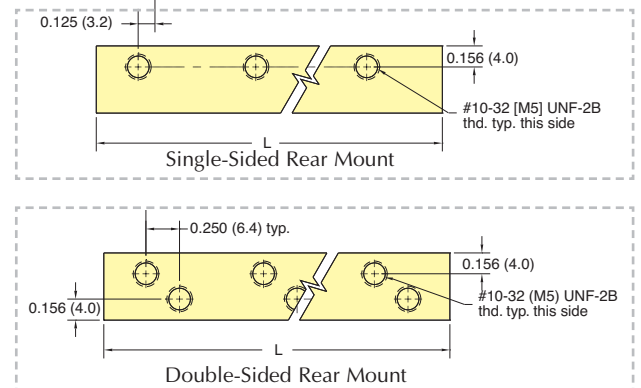



ES & ESO SERIES VALVES SINGLE MANIFOLDS

Single-Station Side Port Manifold

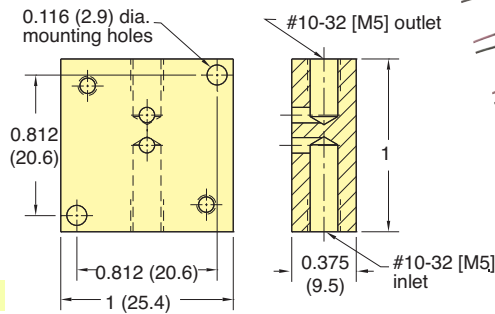

Part No. 26090-1
Description Side Port Manifold

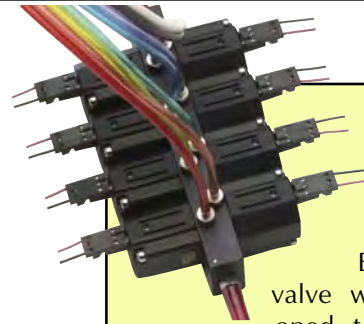

The ES/ESO series valve was developed to fit into tighter physical envelopes. By reducing the size of the base as well as the size of the coil, a considerable volume savings was achieved.

Single-Station Bottom Port Manifold

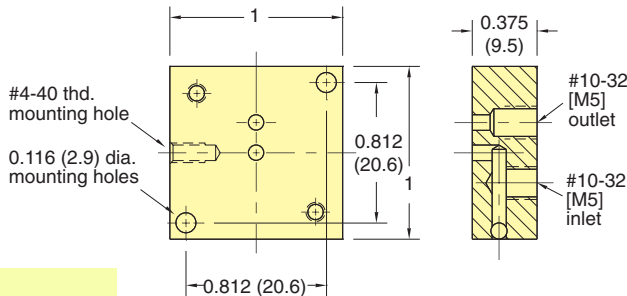

Part No. 26090-2
Description Bottom Port Manifold

As in the case of the EV/EVO product, the ES/ESO uses the single moving part design proven many times in the EV/ET/EC series valves. Of course, given the reduced size of the coil the power to operate increases to 1 watt.

Dual-Station Manifold

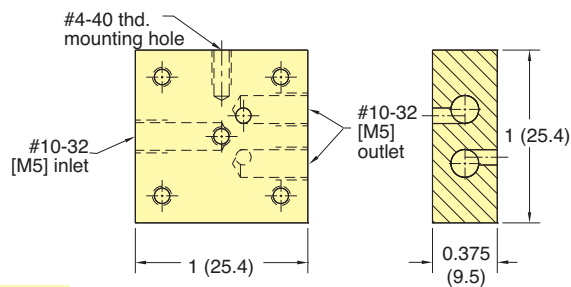

Part No. 26090-3
Description Dual Station Manifold

Because of its reliability, the ES/ESO series valve is found in many of the same applications and industries as its predecessor, the EV/ET/EC. However, the smaller size finds it used more commonly in portable or mobile equipment. This makes the valve particularly applicable in home healthcare applications.

TE Connectivity #5-103956-2 with 18" Wire Leads for ES/ESO Valves

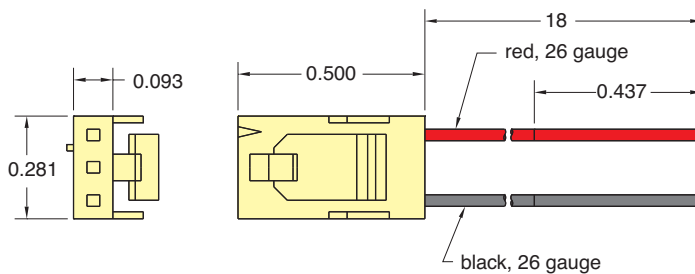

Lead Set Chart For ES Valve						
Part No.	Used On	Wire Colors			Lead Length	Wire Gauge
		Pin 1	Pin 2	Pin 3		
C3-RXB18	ES	red	~	black	18"	#26

10 MM & 15 MM MINIATURE VALVES



All of the benefits of Clippard quality and reliability are now available in these 10 mm and 15 mm valves. Offered in both Normally-Open or Normally-Closed models, these 2-way and 3-way valves are perfect for small areas where compact electronically-controlled pneumatics are needed.

This series has a high strength, engineered light-weight glass filled nylon body, along with stainless steel, copper and Buna-N, making it suitable for a broad range of applications. With exceptional life and reliability this is the perfect sub-miniature valve for tomorrow's needs in a wide variety of industries.



10 mm Standard Series

Direct operating valves well-suited for single- or multiple-valve mounting in small spaces.

[See pages 202 - 204.](#)



10 mm Latching Series

A short pulse of current shifts this valve which "latches" indefinitely; another pulse returns the valve.

[See page 205.](#)



NEW! 10 mm High Flow 2-Way Series

Specialty series for high flow applications.

[See page 206.](#)



NEW! 10 mm ISO 15218 Series

Conforms to ISO standard for mounting and port locations.

[See page 207.](#)



15 mm Standard Series

Direct operating valves well-suited for single- or multiple-valve mounting in small spaces.

[See pages 209 - 211.](#)



15 mm Latching Series

A short pulse of current shifts this valve which "latches" indefinitely; another pulse returns the valve.

[See page 212.](#)



NEW! 15 mm High Flow 2-Way Series

Specialty series for high flow applications.

[See page 213.](#)

All 10 mm and 15 mm valves are RoHS compliant.

Valve Material: Glass filled Nylon, Stainless Steel, Buna-N or Fluorocarbon Elastomer

Electrical: The coil is constructed of copper wire and is insulated according to the class "F" standard. All circuitry and connections are protected from corrosion.

Weight: 10 mm Series: 0.4 oz.; 15 mm Series: 1.3 oz.

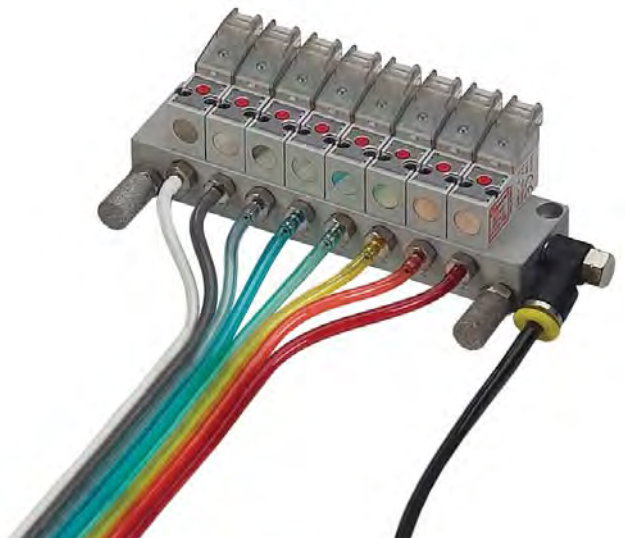



10 MM MINIATURE VALVES

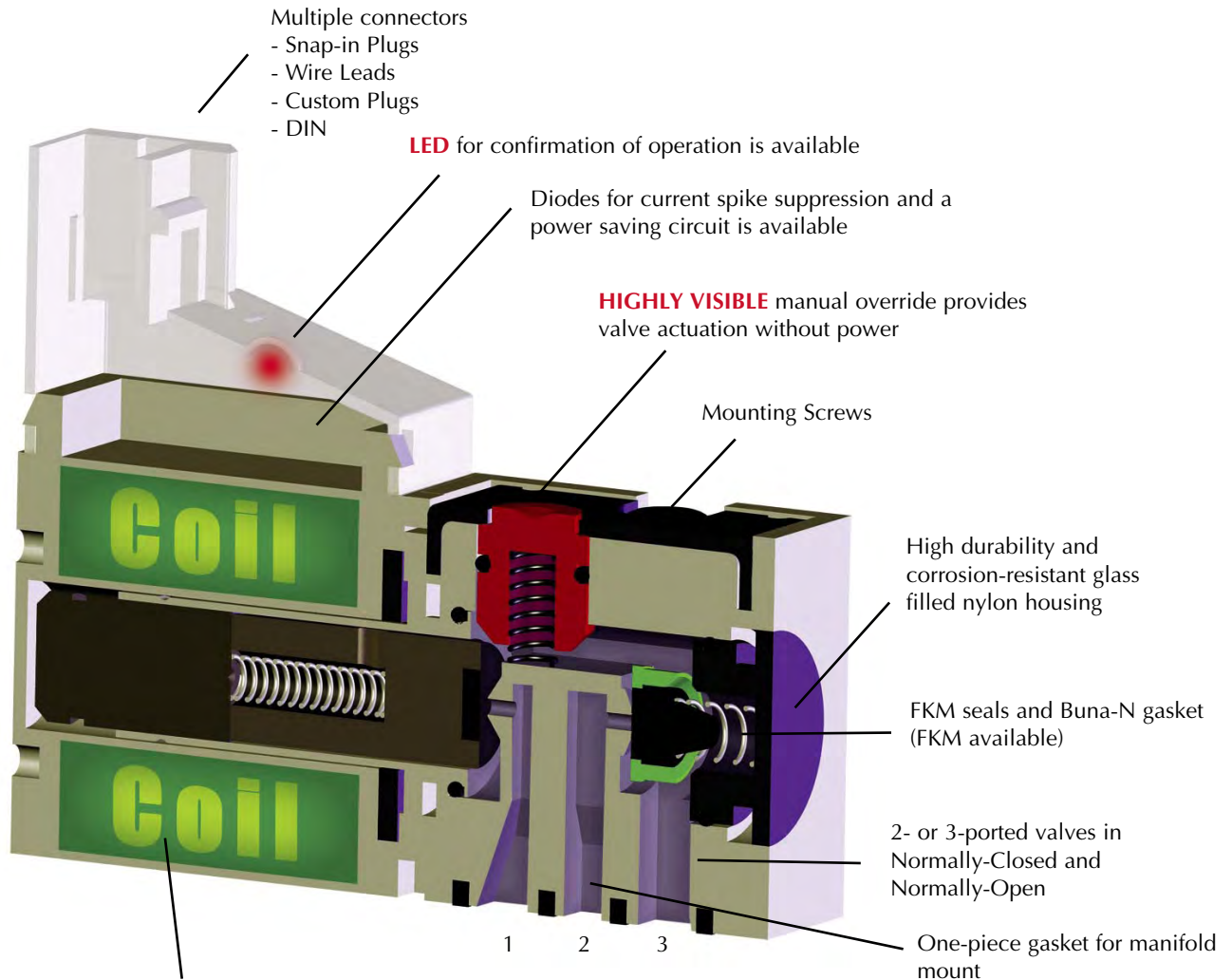

Encapsulated low wattage coils. Available in 12 VDC or 24 VDC. Special voltages available for OEMs.

Config.	1	2	3
N.C.	supply	exhaust	outlet
N.O.	exhaust	supply	outlet

Functional Schematics

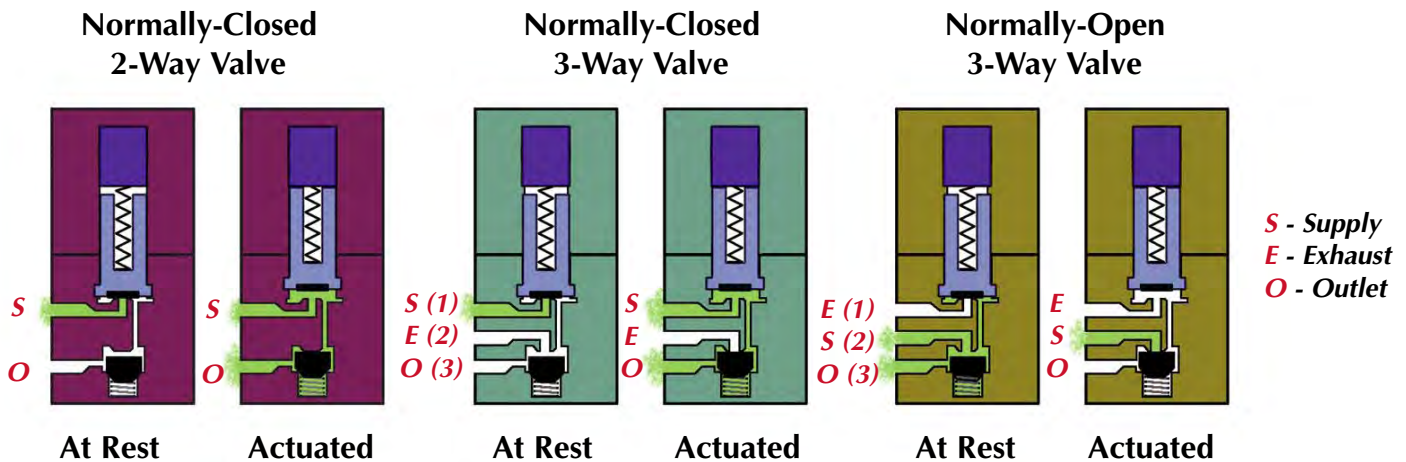

Specifications

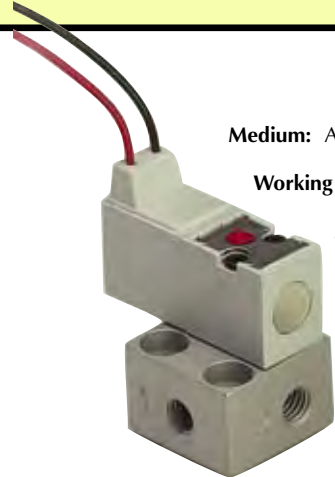

Medium: Air, Gas or other Compatible Fluids

Working Pressure: See Chart below

Max. Flow Rate:

0.020" (0.50 mm) Orifice: 14 l/min (0.5 scfm)
 0.030" (0.75 mm) Orifice: 31.2 l/min (1.1 scfm)

Exhaust Flow:

0.020" (0.50 mm) Orifice: 22.7 l/min (0.8 scfm)
 0.030" (0.75 mm) Orifice: 34 l/min (1.2 scfm)

Response Time: 8 ms when energized; 10 ms when de-energized

Electrical: 12 VDC or 24 VDC

Voltage Tolerance: -5% to 10%

Power Consumption: 0.6 or 1.3 watts dependent on orifice size and pressure

Material: Stainless steel core and springs, nylon body, FKM dynamic seals, and Buna-N gasket and static seals. FKM gasket and static seals available, consult factory.

Coil Insulation Class: F 311°F (155°C)

Temperature Range: 23 to 122°F (-5 to 50°C). When below 32°F (0°C), must use clean, dry air

Order Information

Type	Base No.	Connector	Orifice	Wattage	Working Pressure
2/2 Normally-Closed 	<u>E210A-1E*</u>	90° Connector	0.020"	0.6	14.7 to 110 psig/7.6 bar
	<u>E210C-2E*</u>		0.030"	1.3	0 to 110 psig/7.6 bar
	<u>E210A-1L*</u>	90° Connector with LED	0.020"	0.6	14.7 to 110 psig/7.6 bar
	<u>E210C-2L*</u>		0.030"	1.3	0 to 110 psig/7.6 bar
	<u>E210A-1F*</u>	In-Line Connector	0.020"	0.6	14.7 to 110 psig/7.6 bar
	<u>E210C-2F*</u>		0.030"	1.3	0 to 110 psig/7.6 bar
	<u>E210A-1C*</u>	In-Line Connector with LED	0.020"	0.6	14.7 to 110 psig/7.6 bar
<u>E210C-2C*</u>		0.030"	1.3	0 to 110 psig/7.6 bar	
	<u>E210A-1W*</u>	Wire Leads, 11.8" (300 mm)	0.020"	0.6	14.7 to 110 psig/7.6 bar
	<u>E210C-2W*</u>		0.030"	1.3	0 to 110 psig/7.6 bar
3/2 Normally-Closed 	<u>E310A-1E*</u>	90° Connector	0.020"	0.6	14.7 to 110 psig/7.6 bar
	<u>E310C-2E*</u>		0.030"	1.3	0 to 110 psig/7.6 bar
	<u>E310A-1L*</u>	90° Connector with LED	0.020"	0.6	14.7 to 110 psig/7.6 bar
	<u>E310C-2L*</u>		0.030"	1.3	0 to 110 psig/7.6 bar
	<u>E310A-1F*</u>	In-Line Connector	0.020"	0.6	14.7 to 110 psig/7.6 bar
	<u>E310C-2F*</u>		0.030"	1.3	0 to 110 psig/7.6 bar
	<u>E310A-1C*</u>	In-Line Connector with LED	0.020"	0.6	14.7 to 110 psig/7.6 bar
<u>E310C-2C*</u>		0.030"	1.3	0 to 110 psig/7.6 bar	
	<u>E310A-1W*</u>	Wire Leads, 11.8" (300 mm)	0.020"	0.6	14.7 to 110 psig/7.6 bar
	<u>E310C-2W*</u>		0.030"	1.3	0 to 110 psig/7.6 bar
3/2 Normally-Open 	<u>E3010A-1E*</u>	90° Connector	0.020"	0.6	14.7 to 70 psig/4.8 bar
	<u>E3010C-2E*</u>		0.030"	1.3	0 to 110 psig/7.6 bar
	<u>E3010A-1L*</u>	90° Connector with LED	0.020"	0.6	14.7 to 70 psig/4.8 bar
	<u>E3010C-2L*</u>		0.030"	1.3	0 to 110 psig/7.6 bar
	<u>E3010A-1F*</u>	In-Line Connector	0.020"	0.6	14.7 to 70 psig/4.8 bar
	<u>E3010C-2F*</u>		0.030"	1.3	0 to 110 psig/7.6 bar
	<u>E3010A-1C*</u>	In-Line Connector with LED	0.020"	0.6	14.7 to 70 psig/4.8 bar
<u>E3010C-2C*</u>		0.030"	1.3	0 to 110 psig/7.6 bar	
	<u>E3010A-1W*</u>	Wire Leads, 11.8" (300 mm)	0.020"	0.6	14.7 to 70 psig/4.8 bar
	<u>E3010C-2W*</u>		0.030"	1.3	0 to 110 psig/7.6 bar

* Add Voltage Choice to the end of each Base Part Number. "012" (12 VDC) or "024" (24 VDC).
 Example: **E210A-1C012**



10 MM MINIATURE VALVES

In-Line Connector with LED

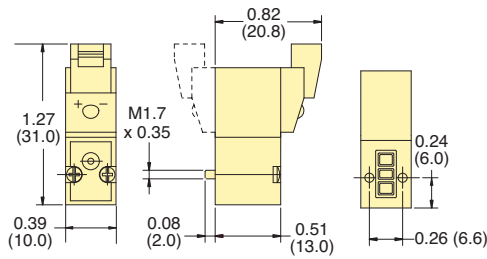

90° Connector with LED

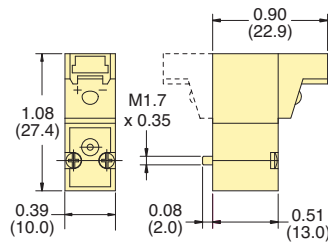

Wire Leads

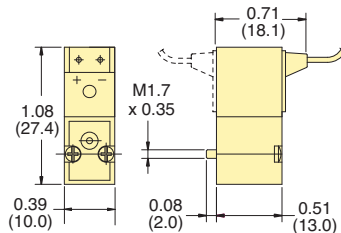

Typical Air Flow

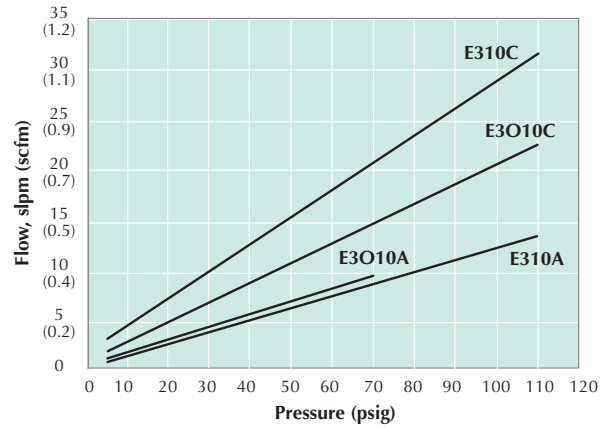

Mounting Interface

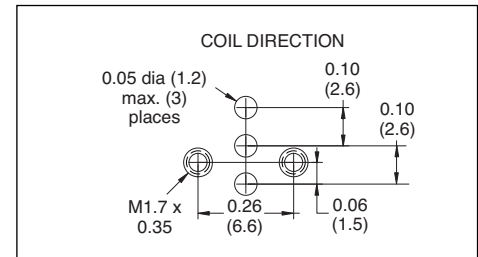

Connectors

Wire Connector must be ordered separately. 24 AWG. Stranding 7/32.



Part No.

- C2A-RB300 Connector with Cable, 11.8" (300 mm)
- C2A-RB500 Connector with Cable, 19.69" (500 mm)
- C2A-RB1000 Connector with Cable, 39.37" (1,000 mm)

Molex terminal insert #050013-8000, #28139 plug and 24 AWG wire.



Custom plugs, wire lengths, connectors and flavors are available for your specific requirements. Call for details.

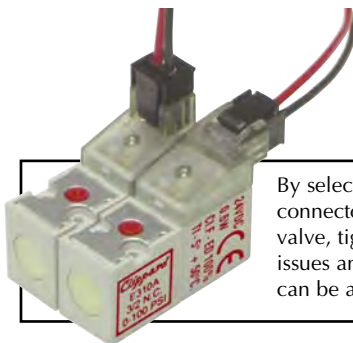

By selecting the appropriate connector type for your 10 mm valve, tight spaces, orientation issues and electrical requirements can be accommodated easily.

Another feature of the Clippard 10 mm valve is the ability to detach the coil and connector from the valve body. This can be useful for the purpose of orientating the coil by 180°, or exchanging connector types or voltages.

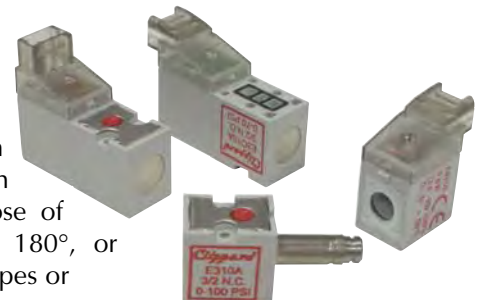

LATCHING 10 MM MINIATURE VALVES



- 2-Way & 3-Way Normally-Closed configurations
- Pulse-actuated (on or off)
- Polarity reverse required
- Stable latch

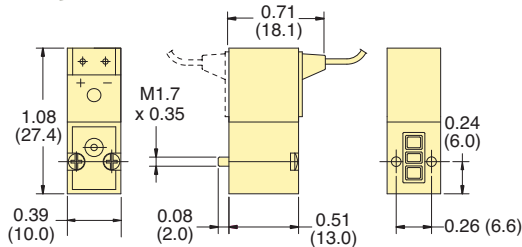

Clippard's 10 mm Latching Valves have many of the same features as the popular 10 mm valve line including small, compact design, exceptional life and reliability, light-weight design and more. A careful balance of forces—through the precise placement of a permanent magnet in the valve core—produces a bi-stable valve. A short pulse of current opens the valve, which “latches” open indefinitely after the current stops. A subsequent pulse of current in the opposite direction closes the valve. The valve consumes less energy and produces less heat than a standard solenoid valve when used in extended duty cycle applications, since the coil is energized for only a small fraction of the total duty cycle.

Max. Flow Rate: 31.2 l/min (1.1 scfm)

Working Pressure: 0 to 110 psig/7.6 bar

Orifice: 0.030" (0.75 mm)

Electrical Connection: 2-Wire Reverse Polarity, 300 mm, 24 AWG

Electrical: 12 VDC (“-012”) or 24 VDC (“-024”). 6 VDC also available. Call for further information.

Electrical Tolerance: -5 to 10%

Response Time: 8 ms when energized; 10 ms when de-energized

Connector: Wire Leads

Copper Wire Isolation Class: F 311°F (155°C)

Material: Stainless steel core and springs, nylon body, FKM dynamic seals, and Buna-N gasket and static seals. FKM gasket available, consult factory.

Temperature Range: 23 to 122°F (-5 to 50°C). When below 32°F (0°C), must use clean, dry air

Medium: Air, Gas or other Compatible Fluids

Type	Part No.	Voltage	Wattage
2-Way	E2L10C-7W012	12 VDC	2.0
	E2L10C-6W024	24 VDC	1.7
3-Way	E3L10C-7W012	12 VDC	2.0
	E3L10C-6W024	24 VDC	1.7

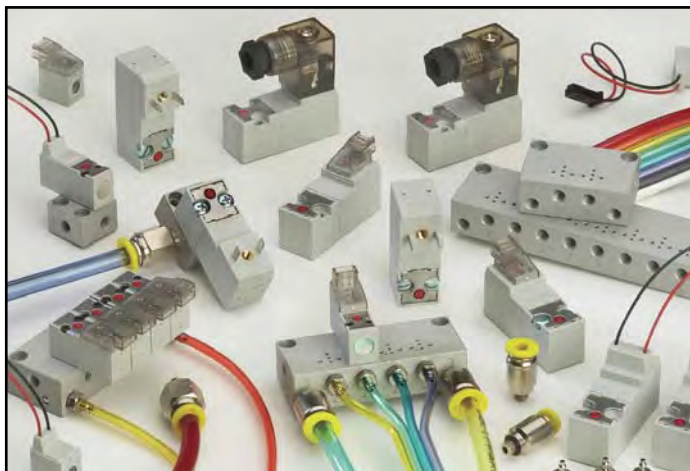

Typical Air Flow

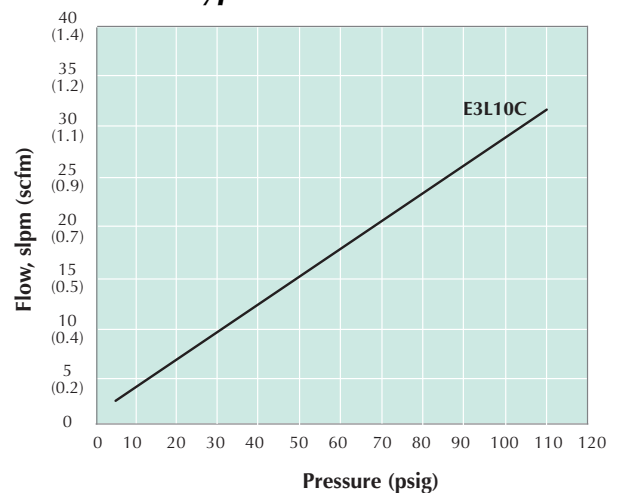

Mounting Interface

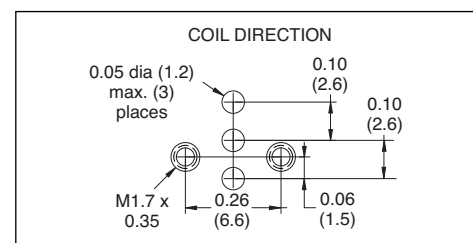

See [pages 204 & 208](#) for connectors and manifolds



NEW! HIGH FLOW 2-WAY 10 MM MINIATURE VALVES

Specifications

Medium: Air, Gas or other Compatible Fluids

Working Pressure: 0 to 30 psig/2.0 bar

Max. Flow Rate: 28 lpm (1.0 scfm)

Orifice: 0.055" (1.4 mm)

Response Time: 8 ms when energized; 10 ms when de-energized

Electrical: 12 VDC or 24 VDC

Power Consumption: 3.5 watts in rush phase; 15 ms/0.35 watts in maintenance phase

Voltage Tolerance: -5% to 10%

Material: Stainless steel core and springs, nylon body, FKM dynamic seals, and Buna-N gasket and static seals. FKM gasket and static seals available, consult factory.

Temperature Range: 23 to 122°F (-5 to 50°C). When below 32°F (0°C), must use clean, dry air

90° Connector with LED

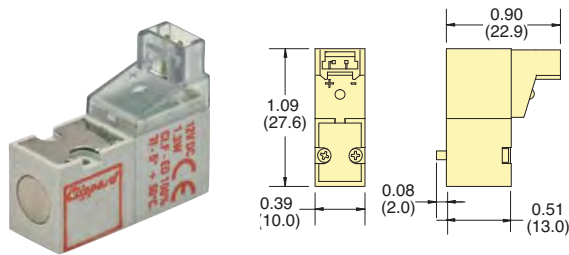

In-Line Connector with LED

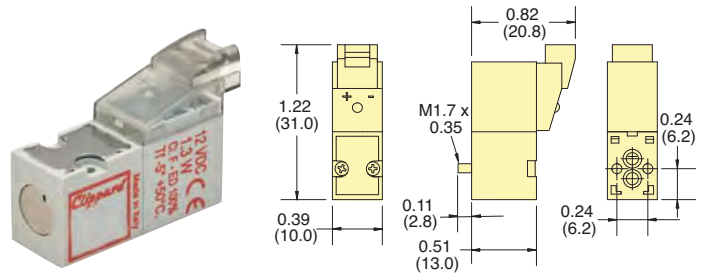

Part No.	Connector	Voltage
E210H-3L012	90° Connector	12 VDC
E210H-3L024	with LED	24 VDC
E210H-3C012	In-Line Connector	12 VDC
E210H-3C024	with LED	24 VDC

Typical Air Flow

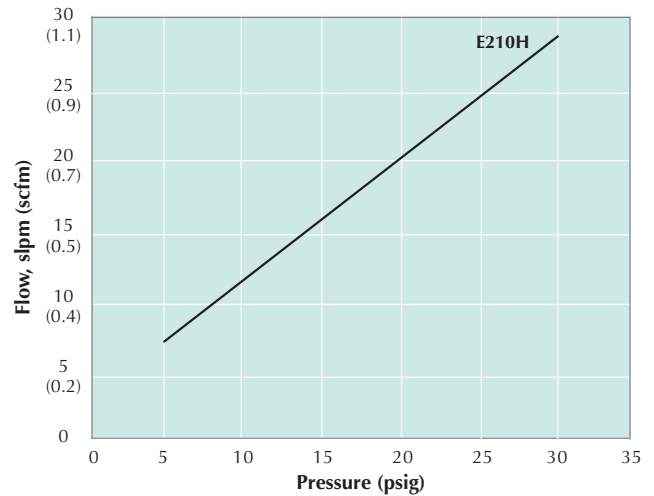

Mounting Interface

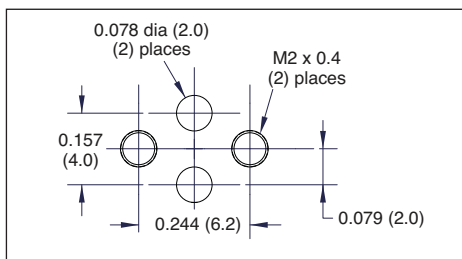

10 mm High Flow Single-Station Manifold

Spare hardware and closing plates available. Add -M5 for metric ports.

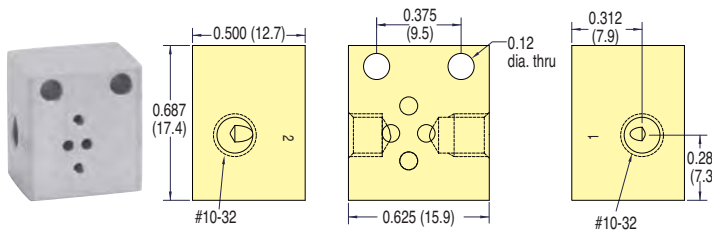

Part No.	Description
E10HM-01	10 mm Single-Station Manifold

Functional Schematics

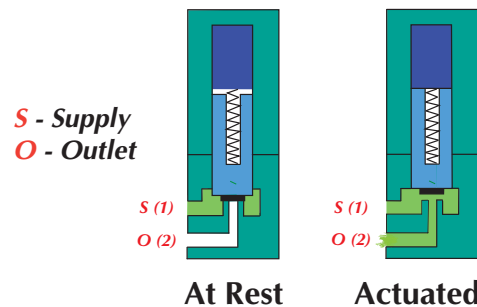

Specifications

Medium: Air, Gas, or other Compatible Fluids

Working Pressure: 0 to 102 psig/7.0 bar

Maximum Flow Rate: 42 l/min (1.5 scfm)

Exhaust Flow: 49 l/min (1.7 scfm)

Orifice: 0.043" (1.1 mm)

Response Time: 8 ms when energized; 10 ms when de-energized

Material: Stainless steel core and springs, nylon body, FKM seals, and Buna-N gasket. FKM gasket available, consult factory

Voltage: 12-volt DC or 24-volt DC

Voltage Tolerance: -5% to 10%

Power Consumption: 3.5 watts in rush phase; 15 ms/0.35 watts in maintenance phase

Coil Insulation Class: F 311°F (155°C)

Temperature Range: 23 to 122°F (-5 to 50°C)

90° Connector with LED

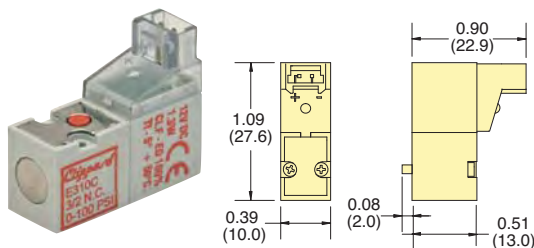

In-Line Connector with LED

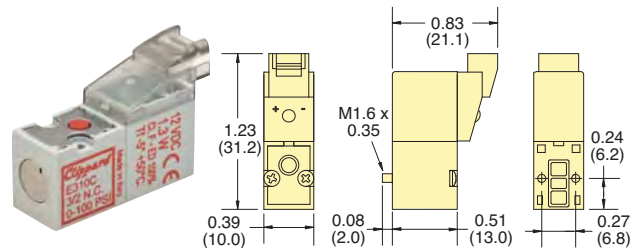

Part No.	Connector	Voltage
E311E-3L012	90° Connector	12 VDC
E311E-3L024	with LED	24 VDC
E311E-3C012	In-Line Connector	12 VDC
E311E-3C024	with LED	24 VDC

Mounting Interface

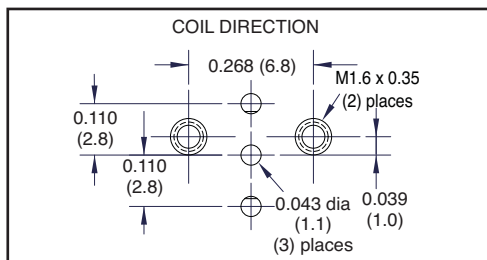

Typical Air Flow

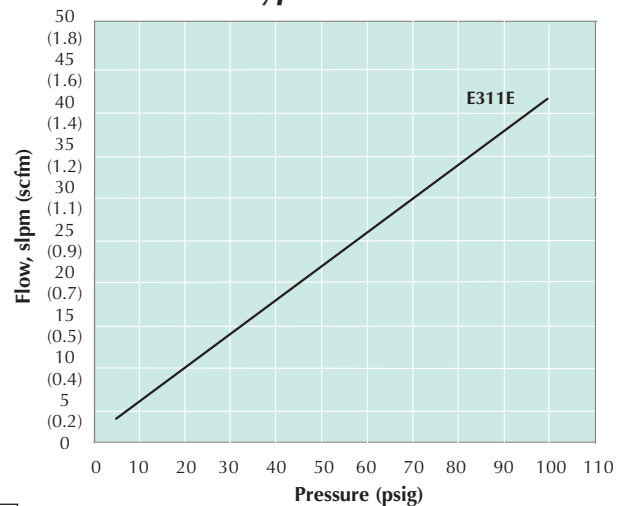

ISO 15218 10 mm High Flow Single-Station Manifold

Spare hardware and closing plates available. Add -M5 for metric ports.

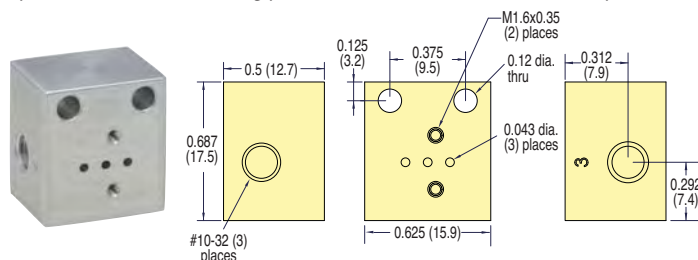

Part No.	Description
E10LM-01	ISO 10 mm Single-Station Manifold

Functional Schematics

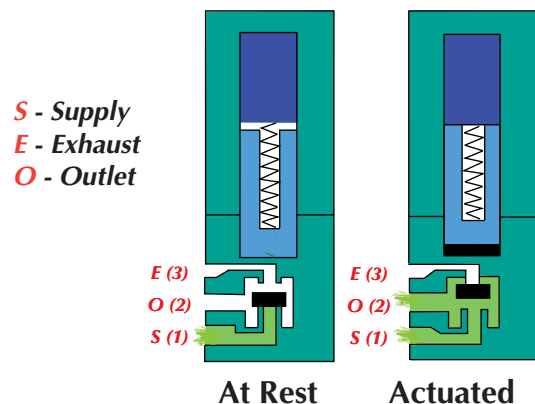

Multiple Connectors

- Snap-in Plugs
- Wire Leads
- DIN Connector
- Spade Terminals
- Custom Plugs

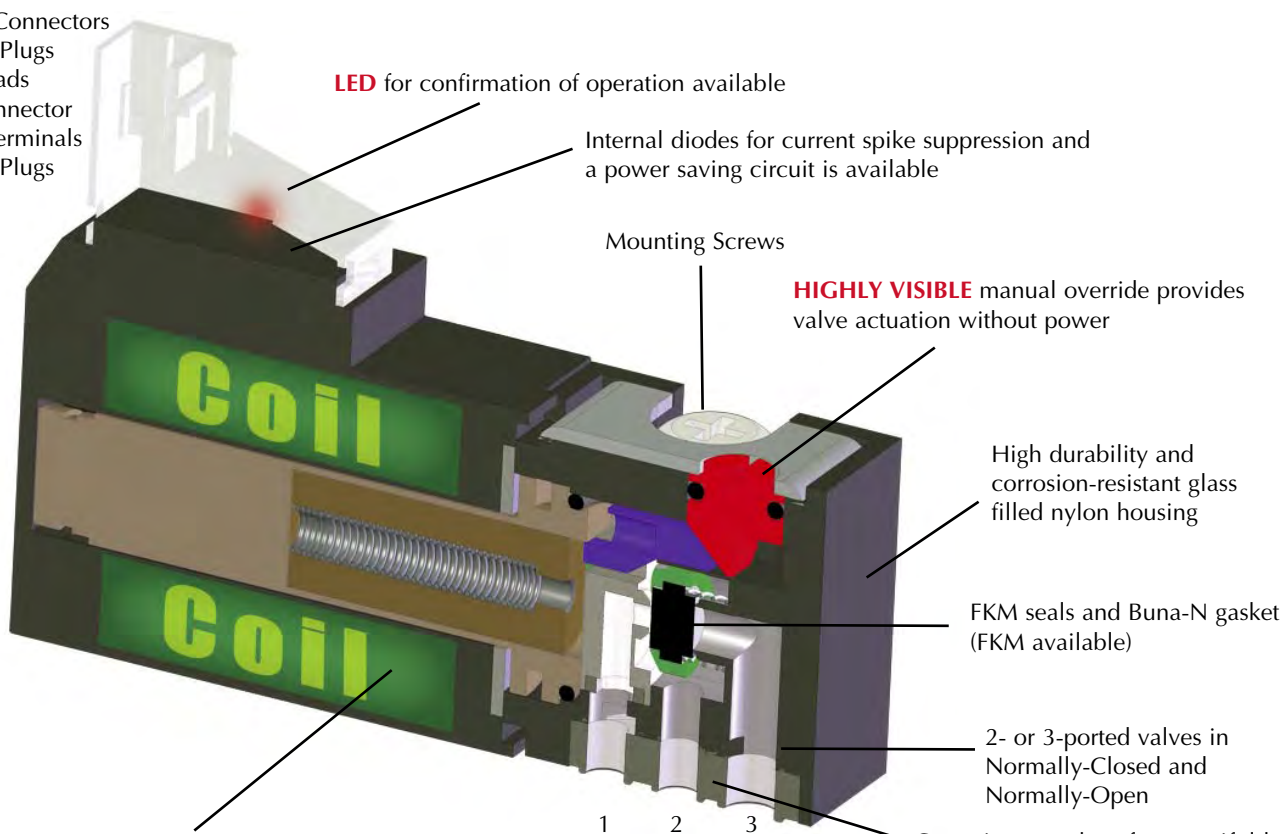

Encapsulated low wattage coils. Available in: 12 VDC, 24 VDC, 24 VAC, 110 VAC or 220 VAC. Special voltages available for OEMs.

Configuration	1	2	3
N.C. & N.O.	exhaust	outlet	supply

One-piece gasket for manifold mounted and supply/exhaust port reversed for same manifold mounting of N.O. or N.C. valve

Functional Schematics

Normally-Closed 3-Way Valve

S - Supply
E - Exhaust
O - Outlet

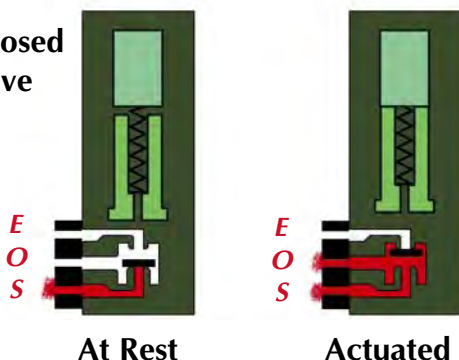

Normally-Open 3-Way Valve

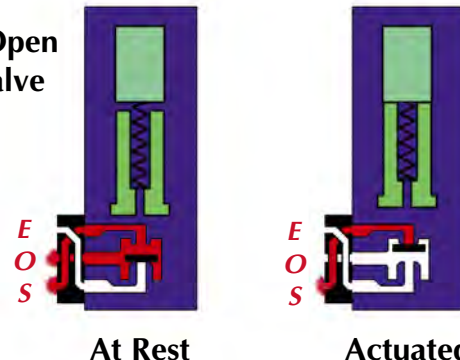

Porting Gasket
The Normally-Open and Normally-Closed configurations allow both models to be mounted on the same manifold.

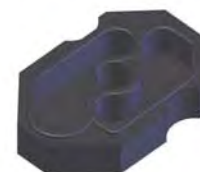



15 MM MINIATURE VALVES

Specifications

Medium: Air, Gas, or other Compatible Fluids

Working Pressure: See Chart below.

Maximum Flow Rate:
 0.032" (0.8 mm) Orifice: 45 l/min (1.6 scfm)
 0.043" (1.1 mm) Orifice: 70 l/min (2.6 scfm)
 0.063" (1.6 mm) Orifice: 91 l/min (3.2 scfm)

Response Time: 10 ms when energized; 12 ms when de-energized



Material: Stainless steel core and springs, springs, nylon body, FKM seals, and Buna-N gasket. FKM gasket available, consult factory

Voltage: 12-volt DC, 24-volt DC or 24-volt AC. 110-volt AC and 220-volt AC only available with DIN Connectors.

Voltage Tolerance: -5% to 10%

Power Consumption: 1.0 or 2.5 watts dependent on orifice size and pressure

Coil Insulation Class: F 311°F (155°C)

Temperature Range: 23 to 122°F (-5 to 50°C)

Order Information

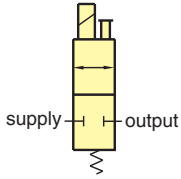
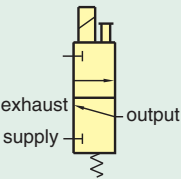
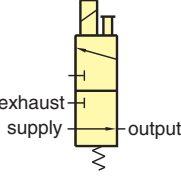
Type	Base No.	Connector	12	24	24	110	220	Orifice	Wattage	Working Pressure
			VDC	VDC	VAC	VAC	VAC			
2/2 Normally-Closed 	E215D-1T*	Terminal	•	•				0.032"	1.0	0 to 150 psig/10.3 bar
	E215E-2T*		•	•	•			0.043"	2.5	0 to 150 psig/10.3 bar
	E215F-2T*		•	•	•			0.063"	2.5	0 to 110 psig/7.6 bar
	E215D-1D*	DIN Connector	•	•				0.032"	1.0	0 to 150 psig/10.3 bar
	E215E-2D*		•	•	•	•		0.043"	2.5	0 to 150 psig/10.3 bar
	E215F-2D*		•	•	•	•		0.063"	2.5	0 to 110 psig/7.6 bar
	E215D-1W*	Wire Leads, 11.8" (300 mm)	•	•				0.032"	1.0	0 to 150 psig/10.3 bar
	E215E-2W*		•	•	•			0.043"	2.5	0 to 150 psig/10.3 bar
	E215F-2W*		•	•	•			0.063"	2.5	0 to 110 psig/7.6 bar
	E215D-1L*	90° Connector with LED	•	•				0.032"	1.0	0 to 150 psig/10.3 bar
E215E-2L*	•		•				0.043"	2.5	0 to 150 psig/10.3 bar	
E215F-2L*	•		•				0.063"	2.5	0 to 110 psig/7.6 bar	
E215D-1C*	In-Line Connector with LED	•	•				0.032"	1.0	0 to 150 psig/10.3 bar	
E215E-2C*		•	•				0.043"	2.5	0 to 150 psig/10.3 bar	
E215F-2C*		•	•				0.063"	2.5	0 to 110 psig/7.6 bar	
3/2 Normally-Closed 	E315D-1T*	Terminal	•	•				0.032"	1.0	0 to 150 psig/10.3 bar
	E315E-2T*		•	•	•			0.043"	2.5	0 to 150 psig/10.3 bar
	E315F-2T*		•	•	•			0.063"	2.5	0 to 110 psig/7.6 bar
	E315D-1D*	DIN Connector	•	•				0.032"	1.0	0 to 150 psig/10.3 bar
	E315E-2D*		•	•	•	•		0.043"	2.5	0 to 150 psig/10.3 bar
	E315F-2D*		•	•	•	•		0.063"	2.5	0 to 110 psig/7.6 bar
	E315D-1W*	Wire Leads, 11.8" (300 mm)	•	•				0.032"	1.0	0 to 150 psig/10.3 bar
	E315E-2W*		•	•	•			0.043"	2.5	0 to 150 psig/10.3 bar
	E315F-2W*		•	•	•			0.063"	2.5	0 to 110 psig/7.6 bar
	E315D-1L*	90° Connector with LED	•	•				0.032"	1.0	0 to 150 psig/10.3 bar
E315E-2L*	•		•				0.043"	2.5	0 to 150 psig/10.3 bar	
E315F-2L*	•		•				0.063"	2.5	0 to 110 psig/7.6 bar	
E315D-1C*	In-Line Connector with LED	•	•				0.032"	1.0	0 to 150 psig/10.3 bar	
E315E-2C*		•	•				0.063"	2.5	0 to 150 psig/10.3 bar	
E315F-2C*		•	•				0.063"	2.5	0 to 110 psig/7.6 bar	
3/2 Normally-Open (110 psig max.) 	E3O15E-2T*	Terminal	•	•	•			0.043"	2.5	0 to 110 psig/7.6 bar
	E3O15F-2T*		•	•	•			0.063"	2.5	0 to 75 psig/5.2 bar
	E3O15E-2D*	DIN Connector	•	•	•	•	•	0.043"	2.5	0 to 110 psig/7.6 bar
	E3O15F-2D*		•	•	•	•	•	0.063"	2.5	0 to 75 psig/5.2 bar
	E3O15E-2W*	Wire Leads, 11.8" (300 mm)	•	•	•			0.043"	2.5	0 to 110 psig/7.6 bar
	E3O15F-2W*		•	•	•			0.063"	2.5	0 to 75 psig/5.2 bar
	E3O15E-2L*	90° Connector with LED	•	•				0.043"	2.5	0 to 110 psig/7.6 bar
	E3O15F-2L*		•	•				0.063"	2.5	0 to 75 psig/5.2 bar
E3O15E-2C*	In-Line Connector with LED	•	•				0.063"	2.5	0 to 110 psig/7.6 bar	
E3O15F-2C*		•	•				0.063"	2.5	0 to 75 psig/5.2 bar	

• Indicates standard items

* Add Voltage Choice to the end of each Base Part Number. "012" (12 VDC), "024" (24 VDC) "24A" (24 VAC), "110" (110 VAC) or "220" (220 VAC). Example: **E315D-1C012**

15 MM MINIATURE VALVES



Terminal Connector



Industrial Form C Connector ordered separately below.

DIN Connector



In-Line Connector with LED



Wire Leads



DIN Connector ordered separately below.

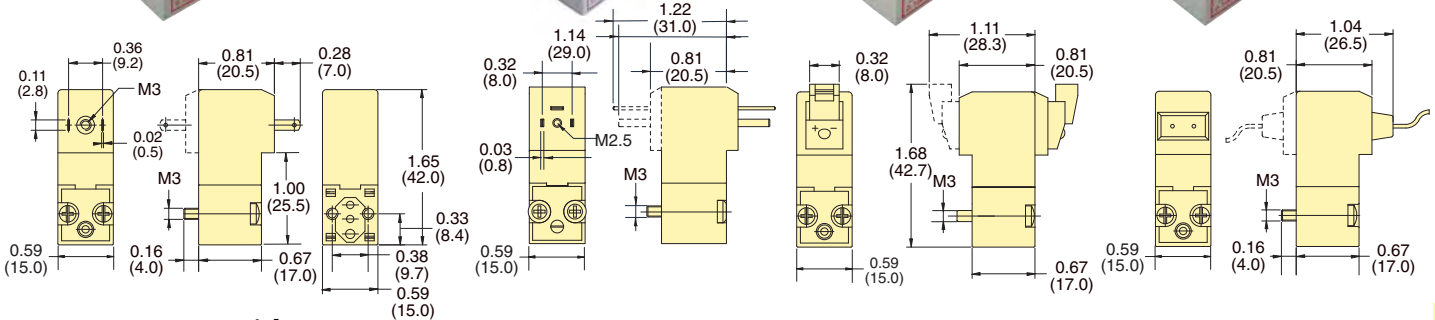

90° Connector with LED

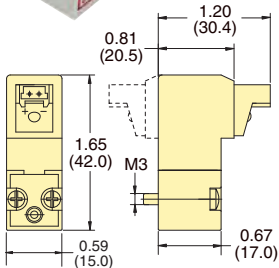

Typical Air Flow

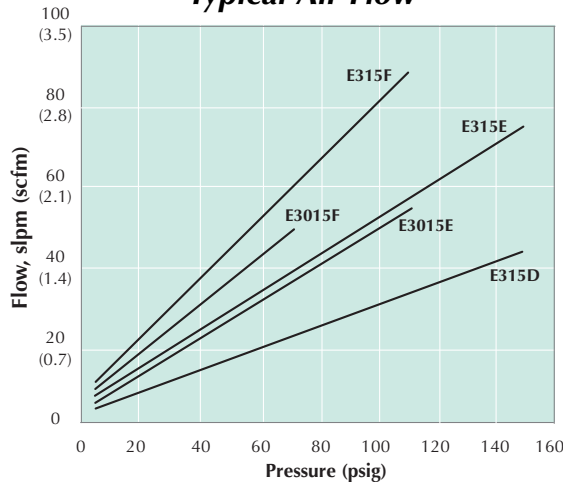

Mounting Interface

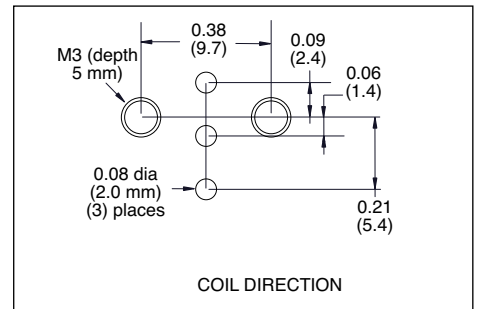

DIN Connectors

For Use with 15 mm Valves Only

DIN 43650 Form C Connectors with 8 mm spade center spacing mate with the 15 mm DIN connector coil. Industrial Form Connectors with 9.4 mm spade center spacing are designed to connect to 15 mm terminal coils. Both are available with or without surge suppression, and 152 or 381 mm PVC molded three-wire cord set.

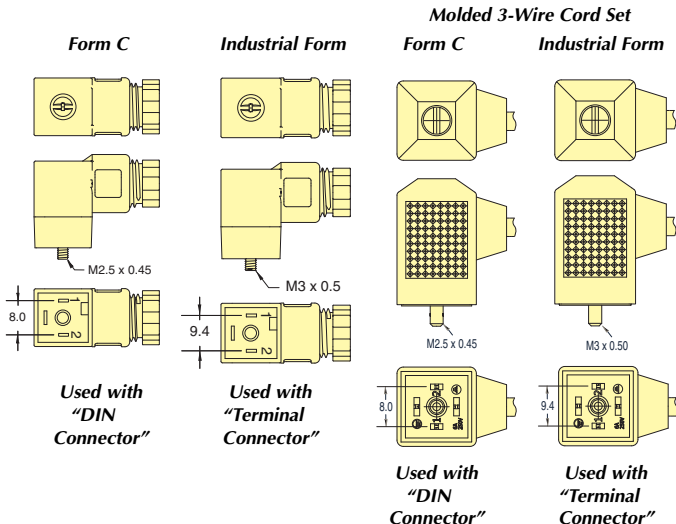

Form C Part No.	Industrial Form Part No.	Volts	LED	Cord
CC-C	CC-I	6-240	no	-
CC-C-P6	CC-I-P6	6-240	no	6'
CC-C-P15	CC-I-P15	6-240	no	15'
CC-CLL	CC-ILL	6-24	yes	-
CC-CLL-P6	CC-ILL-P6	6-24	yes	6'
CC-CLL-P15	CC-ILL-P15	6-24	yes	15'
CC-CLM	CC-ILM	48-110	yes	-
CC-CLM-P6	CC-ILM-P6	48-110	yes	6'
CC-CLM-P15	CC-ILM-P15	48-110	yes	15'



LATCHING 15 MM MINIATURE VALVES



- 2-Way & 3-Way Normally-Closed configurations
- Pulse-actuated (on or off)
- 3-wire coil. No polarity reverse required
- Stable latch

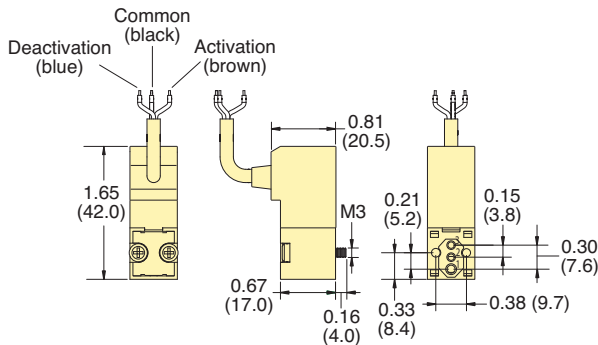

Clippard's 15 mm Latching Valves have many of the same features as the popular 15 mm standard valve line including small, compact design, exceptional life and reliability, light-weight design and more. A careful balance of forces—through the precise placement of a permanent magnet in the valve core—produces a bi-stable valve. A short pulse of current opens the valve, which “latches” open indefinitely after the current stops. A subsequent pulse of current in the opposite direction closes the valve. The valve consumes less energy and produces less heat than a standard solenoid valve when used in extended duty cycle applications, since the coil is energized for only a small fraction of the total duty cycle.

Medium: Air, Gas or other Compatible Fluids

Max. Flow Rate: 0.043" (1.1 mm) Orifice: 59 l/min (2.1 scfm)
0.063" (1.6 mm) Orifice: 84 l/min (3.0 scfm)

Electrical Connection: 3-Wire Molded Cord, 300 mm, 24 AWG 4.5 mm external jacket; tinned copper wires; silicone jacket and conductor insulation

Electrical: 12 VDC (“-012”) or 24 VDC (“-024”). 6 VDC also available. Call for further information.

Electrical Tolerance: -5 to 10%

Response Time: 10 ms when energized; 12 ms when de-energized

Copper Wire Isolation Class: F 311°F (155°C)

Material: Stainless steel core and springs, nylon body, FKM dynamic seals, and Buna-N gasket and static seals. FKM gasket available, consult factory.

Temperature Range: 23 to 122°F (-5 to 50°C). When below 32°F (0°C), must use clean, dry air

Mounting Interface

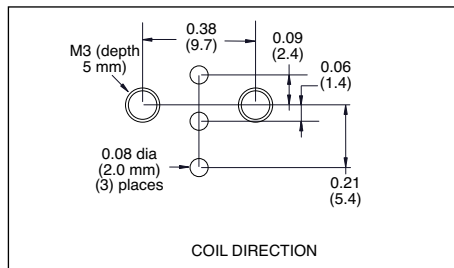

Typical Air Flow

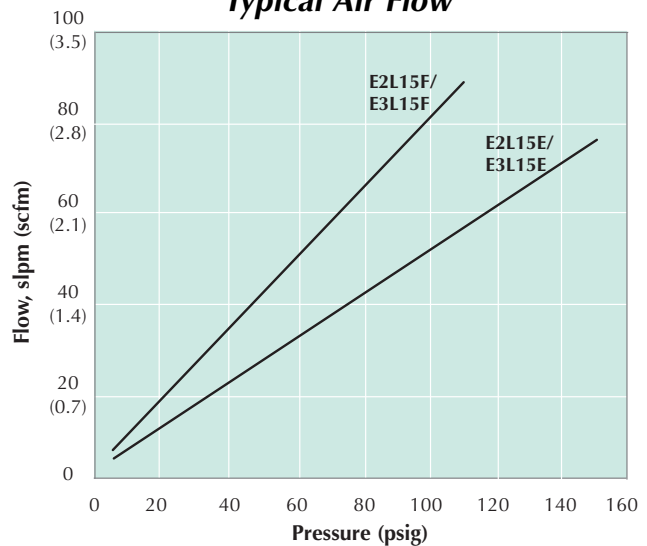

Type	Part No.	Connector	Orifice	Voltage	Wattage	Pressure Range
2-Way	E2L15E-4W012	3-Wire Molded Cord, 300 mm	0.043" (1.1 mm)	12 VDC	4.0	0 to 150 psig/10.3 bar
	E2L15E-4W024		0.043" (1.1 mm)	24 VDC		0 to 150 psig/10.3 bar
	E2L15F-4W012		0.063" (1.6 mm)	12 VDC		0 to 110 psig/7.6 bar
	E2L15F-4W024		0.063" (1.6 mm)	24 VDC		0 to 110 psig/7.6 bar
3-Way	E3L15E-4W012	3-Wire Molded Cord, 300 mm	0.043" (1.1 mm)	12 VDC	4.0	0 to 150 psig/10.3 bar
	E3L15E-4W024		0.043" (1.1 mm)	24 VDC		0 to 150 psig/10.3 bar
	E3L15F-4W012		0.063" (1.6 mm)	12 VDC		0 to 110 psig/7.6 bar
	E3L15F-4W024		0.063" (1.6 mm)	24 VDC		0 to 110 psig/7.6 bar

See [page 214](#) for connectors and manifolds

Specifications

Medium: Air, Gas, or other Compatible Fluids

Working Pressure: 0 to 43 psig/3.0 bar

Maximum Flow Rate: 120 l/min (4.3 scfm)

Orifice: 0.118" (3.0 mm)

Material: Stainless steel core and springs, nylon body, FKM seals, and Buna-N gasket. FKM gasket available, consult factory

Response Time: 10 ms when energized; 12 ms when de-energized

Voltage: 12-volt DC or 24-volt DC

Voltage Tolerance: -5% to 10%

Power Consumption: 4.0 watts

Coil Insulation Class: F 311°F (155°C)

Temperature Range: 23 to 122°F (-5 to 50°C)

90° Connector with LED

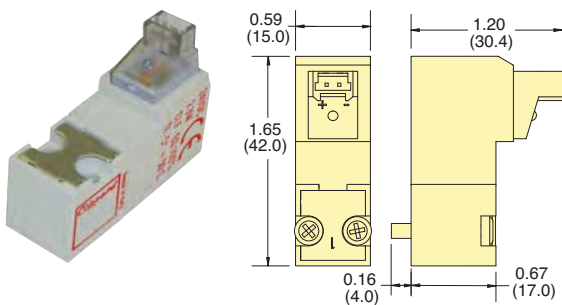

In-Line Connector with LED

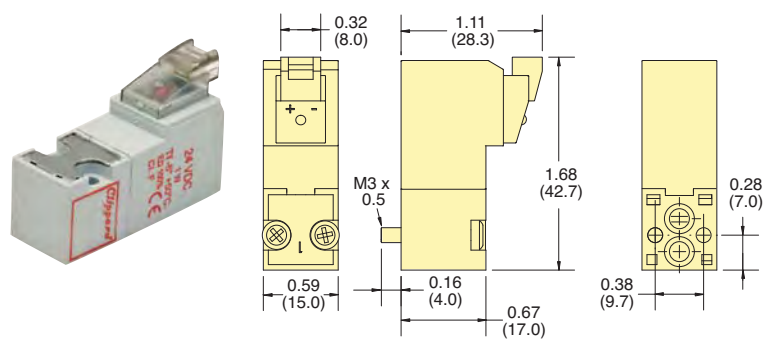

Part No.	Connector	Voltage
E215H-3L012	90° Connector	12 VDC
E215H-3L024	with LED	24 VDC
E215H-3C012	In-Line Connector	12 VDC
E215H-3C024	with LED	24 VDC

Typical Air Flow

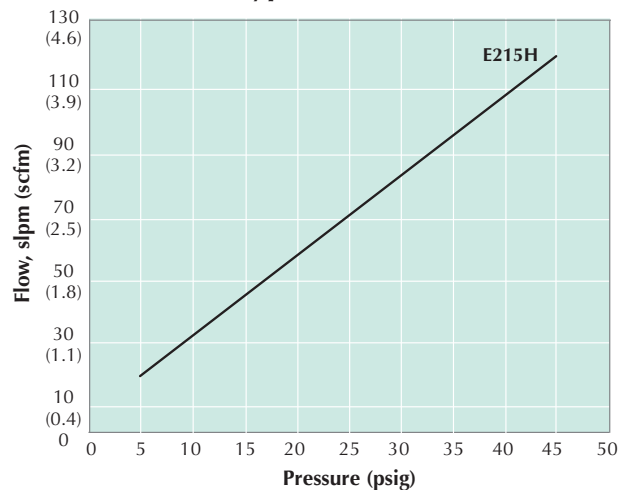

Mounting Interface

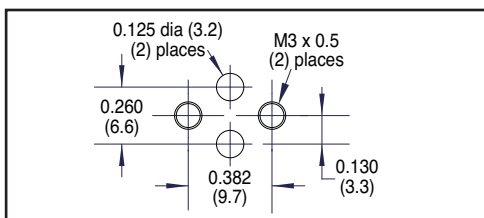

15 mm High Flow Single-Station Manifold

Spare hardware and closing plates available. Add -M5 for metric ports.

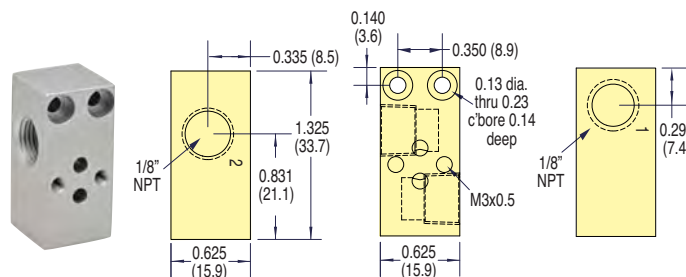

Part No.
[E15HM-01](#) 15 mm Single-Station Manifold

Functional Schematics

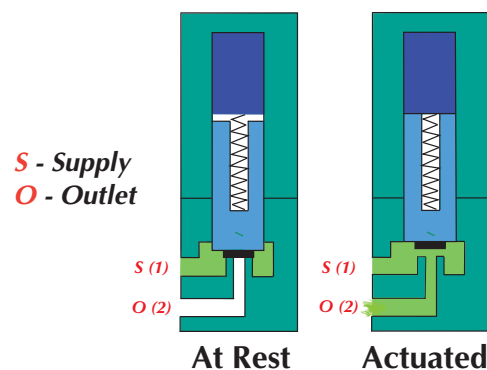

Maximatic®



Maximatic Solenoid Valves

Clippard's Maximatic Solenoid valves are available in 2-way, 3-way and 4-way configurations in port sizes from #10-32 to 1/2" NPT. Select either a direct-acting poppet or solenoid-controlled pilot operated balanced spool design. Spool valves are body ported but can be bolted to a parallel circuit manifold.

These electronic valves offer high flow in a small package, and are constructed of aluminum, stainless steel and thermoplastic materials. The 4-way valves are also available in 3 position versions with either pressure center, closed center or exhaust center spool options.

Materials: Aluminum, Stainless Steel, Thermoplastic

Maximum Pressure: 0 to 115 psig (direct-acting only); 30 to 125 on MME-41 Series, 20 to 125 psig on all others (spool valves)

Response Time: Less than 20 milliseconds

Mounting: Manifold standard. Actuator (1/4" only) or NAMUR (3/8" NPT only) available.

Manual Override: Locking or non-locking

Electrical Connection: DIN terminal with LED indicator, or 18" Wire Leads

DIN Connector: Plug-in electrical connector with LED. MME-31/41 models are DIN Industrial Form "C" (9.4 mm centers) 3 mm screw. All others are DIN 43650 Form "B" 3 mm screw. LED will not "light" if polarity is reversed.

Wire Leads: Not polarity sensitive

Temperature Range: 32 to 150°F (0 to 65°C)

Seals: Buna-N

Conforms to ISO 19973-2 test standards.

3- & 4-Way Valves

Port	Cv	Flow Rate	
		@ 50 psig	@ 100 psig
#10-32	0.58	16 scfm	27 scfm
1/8" NPT	0.67	18 scfm	31 scfm
1/4" NPT	0.89	26 scfm	49 scfm
3/8" NPT	1.68	51 scfm	93 scfm
1/2" NPT	2.79	91 scfm	171 scfm



Maximum Value. Maximum Performance.

For side ported manifold mount, the Maximatic line of valves offers both 1/4" actuator mount and 3/8" NAMUR mount

2-, 3- & 4-Way Designs

Choose either DIN connector with LED indicator or 18" Wire Lead connection. Both are rotatable and interchangeable.

Easily accessible locking or non-locking manual override switch

Port sizes from #10-32 to 1/2" NPT

Small size makes valves ideal for use in compact applications



Buna-N Seals

Sturdy aluminum body withstands rough environments

Operating ranges to 125 psig

Closed Center, Pressure Center and Exhaust Center Models Available

Maximatic® Valves are available as body ported, manifold mount, NAMUR (3/8" NPT only), and Actuator (1/4" NPT only) mounting. Standard models include a base that permits fast, secure mounting of electronic valves to a manifold for grouping in compact assemblies.

A wide variety of voltage options are available including 12 VDC, 24 VDC, 24 VAC, 110 VAC and 220 VAC. Consult factory for other voltages.

All Maximatic® Solenoid Valves are IP 65 CE Rating

MAXIMATIC® SOLENOID VALVES



Valve Series	Enter	<input type="text"/>
Electronic	E	<input type="text"/>
Air Pilot	A	
Valve Type	Enter	<input type="text"/>
2-Way (Direct-Acting only)	2	<input type="text"/>
3-Way	3	
4-Way	4	
Body/Port Size	Enter	<input type="text"/>
Direct-Acting		<input type="text"/>
1/8" NPT	P	
1/8" NPT Stacking	S	
1/4" NPT	Q	
Spool Type		<input type="text"/>
#10-32	1N	<input type="text"/>
1/8" NPT	1P	
1/4" NPT (0.89 Cv)	2Q	
1/4" NPT (1.68 Cv)	3Q	
3/8" NPT	3W	
1/2" NPT	4Z	
Primary/Secondary Actuator	Enter	<input type="text"/>
Air/Air	AA	<input type="text"/>
Air/Spring	AS	
Electronic Pilot/Elec. Pilot	EE	
Electronic Pilot/Spring	ES	
Direct Acting/Spring	DS (2- or 3-Way, #10-32, 1/8", 1/4" only)	
Mounting	Enter	<input type="text"/>
Standard Manifold	(blank)	* Only available on 3- or 4-Way Electronic Valves. 1/4" NPT Actuator or 3/8" NPT NAMUR Mount.
Actuator/NAMUR*	B	
Spool Type	Enter	<input type="text"/>
2-Position, Spool	(blank)	Only available on 4-Way Valves with "AA" or "EE" Actuator. Standard Manifold Mount only.
3-Position, Closed Center	C	
3-Position, Exhaust Center	E	
3-Position, Pressure Center	P	
Electrical Connector	Enter	<input type="text"/>
DIN Connector	D	Only required on Electronic Valves.
Wire Leads (18")	W	
Voltage	Enter	<input type="text"/>
12-Volt DC	012	Only required on Electronic Valves.
24-Volt DC	024	
24-Volt AC	24A	
110-Volt AC	110	
220-Volt AC	220	



Single Solenoid Electronic Valves Mounted on 8-Station Manifold

Note: This numbering schematic is shown for illustration purposes only. All possible configurations are not available. For standard models, see the products illustrated in this catalog.



Example: MM E - 4 2Q ES - D 110



MAXIMATIC® SOLENOID VALVES

2-Way Valves										
Series No.	Style	Inlet	Ports Outlet	Exhaust	Function	Cv	Flow @ 100 psig			
MME-2PDS	Poppet	1/8" NPT	1/8" NPT	1/8" NPT	2/2	0.12	6.7 scfm			
MME-2QDS	Poppet	1/4" NPT	1/4" NPT	1/4" NPT	2/2	0.12	6.7 scfm			
MME-2SDS	Poppet	1/8" NPT	1/8" NPT	1/8" NPT	2/2	0.05	2.3 scfm			
3-Way Valves										
MME-3PDS	Poppet	1/8" NPT	1/8" NPT	1/8" NPT	3/2	0.12	6.7 scfm			
MME-3QDS	Poppet	1/4" NPT	1/4" NPT	1/4" NPT	3/2	0.12	6.7 scfm			
MME-3SDS	Poppet	1/8" NPT	1/8" NPT	1/8" NPT	3/2	0.05	2.3 scfm			
MME-31NES	Spool	#10-32	#10-32	#10-32	3/2 NC	0.58	27 scfm			
MME-31PES	Spool	1/8" NPT	1/8" NPT	1/8" NPT	3/2 NC	0.67	31 scfm			
MME-32QES	Spool	1/4" NPT	1/4" NPT	1/8" NPT	3/2 NC	0.89	49 scfm			
MME-33WES	Spool	3/8" NPT	3/8" NPT	1/4" NPT	3/2 NC	1.68	93 scfm			
MME-34ZES	Spool	1/2" NPT	1/2" NPT	1/2" NPT	3/2 NC	2.79	171 scfm			
MME-31NEE	Spool	#10-32	#10-32	#10-32	3/2	0.58	27 scfm			
MME-31PEE	Spool	1/8" NPT	1/8" NPT	1/8" NPT	3/2	0.67	31 scfm			
MME-32QEE	Spool	1/4" NPT	1/4" NPT	1/8" NPT	3/2	0.89	49 scfm			
MME-33WEE	Spool	3/8" NPT	3/8" NPT	1/4" NPT	3/2	1.68	93 scfm			
MME-34ZEE	Spool	1/2" NPT	1/2" NPT	1/2" NPT	3/2	2.79	171 scfm			
4-Way Valves										
Series No.	Style	Inlet	Ports Outlet	Exhaust	Function	Cv	Flow @ 100 psig	Spool Configuration		
								Flow @ 100 psig	Closed Center	Exhaust Center
MME-41NES	Spool	#10-32	#10-32	#10-32	5/2	0.58	27 scfm			
MME-41PES	Spool	1/8" NPT	1/8" NPT	1/8" NPT	5/2	0.67	31 scfm			
MME-42QES	Spool	1/4" NPT	1/4" NPT	1/8" NPT	5/2	0.89	49 scfm			
MME-43WES	Spool	3/8" NPT	3/8" NPT	1/4" NPT	5/2	1.68	93 scfm			
MME-44ZES	Spool	1/2" NPT	1/2" NPT	1/2" NPT	5/2	2.79	171 scfm			
MME-41NEE	Spool	#10-32	#10-32	#10-32	5/2	0.58	27 scfm			
MME-41PEE	Spool	1/8" NPT	1/8" NPT	1/8" NPT	5/2	0.67	31 scfm			
MME-42QEE	Spool	1/4" NPT	1/4" NPT	1/8" NPT	5/2	0.89	49 scfm			
MME-43WEE	Spool	3/8" NPT	3/8" NPT	1/4" NPT	5/2	1.68	93 scfm			
MME-44ZEE	Spool	1/2" NPT	1/2" NPT	1/2" NPT	5/2	2.79	171 scfm			
MME-41NEEC	Spool	#10-32	#10-32	#10-32	5/3	0.50	23 scfm		•	
MME-41PEEC	Spool	1/8" NPT	1/8" NPT	1/8" NPT	5/3	0.50	23 scfm		•	
MME-42QEEC	Spool	1/4" NPT	1/4" NPT	1/8" NPT	5/3	0.67	49 scfm		•	
MME-43WEEC	Spool	3/8" NPT	3/8" NPT	1/4" NPT	5/3	1.00	72 scfm		•	
MME-44ZEEC	Spool	1/2" NPT	1/2" NPT	1/2" NPT	5/3	1.68	93 scfm		•	
MME-41NEEP	Spool	#10-32	#10-32	#10-32	5/3	0.50	23 scfm			•
MME-41PEEP	Spool	1/8" NPT	1/8" NPT	1/8" NPT	5/3	0.50	23 scfm			•
MME-42QEEP	Spool	1/4" NPT	1/4" NPT	1/8" NPT	5/3	0.89	49 scfm			•
MME-43WEEP	Spool	3/8" NPT	3/8" NPT	1/4" NPT	5/3	1.00	72 scfm			•
MME-44ZEEP	Spool	1/2" NPT	1/2" NPT	1/2" NPT	5/3	1.68	93 scfm			•
MME-41NEEE	Spool	#10-32	#10-32	#10-32	5/3	0.50	23 scfm		•	
MME-41PEEE	Spool	1/8" NPT	1/8" NPT	1/8" NPT	5/3	0.50	23 scfm		•	
MME-42QEEE	Spool	1/4" NPT	1/4" NPT	1/8" NPT	5/3	0.89	49 scfm		•	
MME-43WEEE	Spool	3/8" NPT	3/8" NPT	1/4" NPT	5/3	1.00	72 scfm		•	
MME-44ZEEE	Spool	1/2" NPT	1/2" NPT	1/2" NPT	5/3	1.68	93 scfm		•	



Direct-Acting 2-Position Solenoid Valves



Maximatic® Direct-Acting Valves are single solenoid spring return poppet type valves available as either 2-way or 3-way configurations in ports sizes 1/8" NPT and 1/4" NPT. Hardware to stack multiple valves included with each stacking valve (MME-3SDS and MME-2SDS). Includes one long screw, one short screw, one gasket, and one nut.

- Flow:** 2.3 scfm @ 100 psig
- Electrical Connection:** DIN connector with LED indicator ("D"), or 18" Wire Lead ("W")
- Voltage:** 12-volt DC ("-012"), 24-volt DC ("-024"), 24-volt AC ("-24A"), 110-volt AC ("-110"), or 220-volt AC ("-220")
- Power Consumption:** 6.5 Watt
- Number of Ports:** 2 or 3
- Mounting:** Body Ported or Stacking

Medium: Air (40 micron filtration), Inert Gas or Liquid
Operating Range: 0 to 115 psig

Replacement Stacking Kit

Replacement Stacking Kits are available which include two long screws, two short screws, one gasket and two nuts.

Part No.
27048

Replacement Stacking Kit

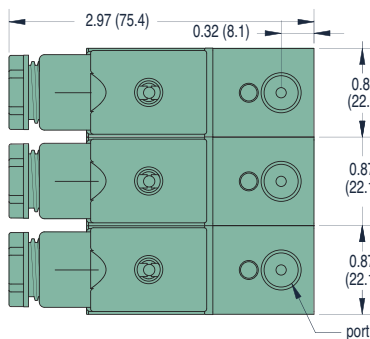

3-Station Configuration

2-Way & 3-Way Valves (Stacking)

2-Way & 3-Way Valves (non-Stacking)

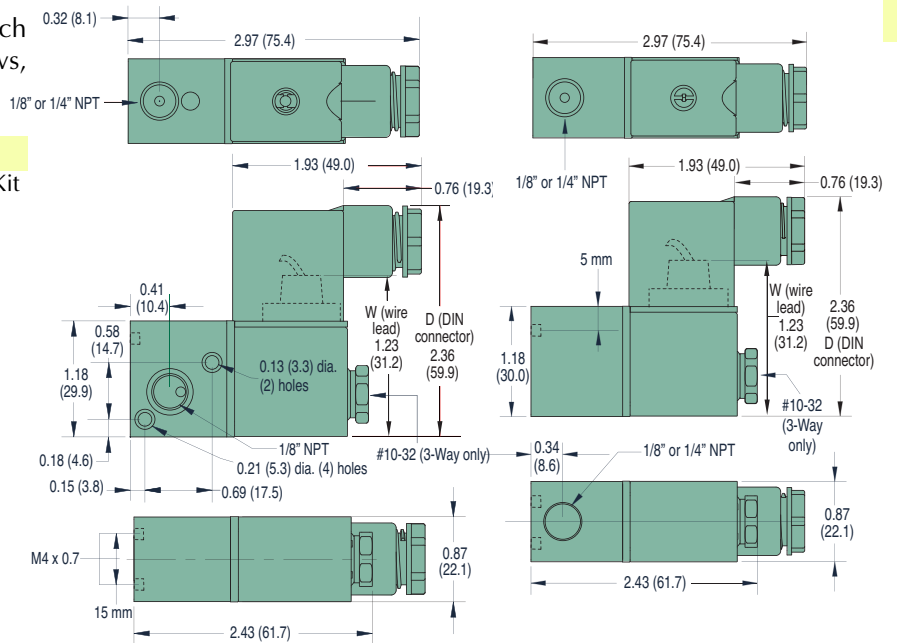

2-Way Valves	Cv/scfm*	3-Way Valves	Inlet	Outlet	Exhaust	Cv/scfm*
MME-2PDS- A	0.12/6.7	MME-3PDS- A	1/8" NPT	1/8" NPT	#10-32	0.10/2.3
MME-2SDS-** W	0.05/2.3	MME-3SDS-** W	1/8" NPT	1/8" NPT	#10-32	0.10/2.3
MME-2QDS- P	0.12/6.7	MME-3QDS- P E	1/4" NPT	1/4" NPT	#10-32	0.10/2.3

** Stacking Valve

* scfm based on flow @ 100 psig

Add Electrical Connection and Voltage Choices to the end of each Base Part Number - Example: **MME-2QDS-W220**



MAXIMATIC® 3-WAY VALVES

2-Position Single & Double Solenoid Valves

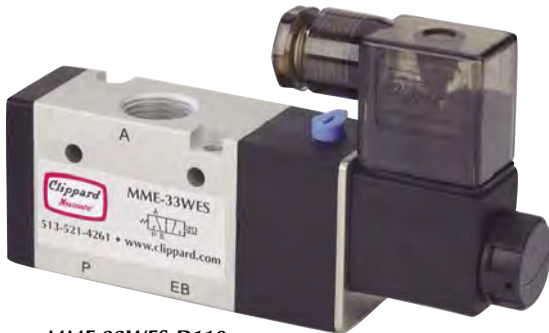

MME-33WES-D110



MME-32QEE-D110

Maximatic® 3-way electronic valves are either N.C. single solenoid spring return or double solenoid spool valves in #10-32 to 1/2" NPT port sizes.

Medium: Air (40 micron filtration) or Inert Gas

Operating Range: 20 to 125 psig

Electrical Connection: DIN connector with LED indicator ("-D"), or 18" Wire Lead ("-W")

Voltage: 12-volt DC ("-012"), 24-volt DC ("-024"), 24-volt AC ("-24A"), 110-volt AC ("-110"), or 220-volt AC ("-220")

Number of Ports: 3

Mounting: Body Ported, Manifold Mount, Actuator (1/4" NPT only) or NAMUR (3/8" NPT only) available. See [Page 221](#).

Manual Override: Non-locking on MME-31 series. Locking on all other models.

Power Consumption: 2.5 Watts on MME-31 series; 3 Watts for all others.

MAXIMUM
Value. → Performance.

Dim.	MME-31	MME-32	MME-33	MME-34
D	2.14 (54.4)	2.65 (67.3)	2.71 (68.8)	2.94 (74.7)
DS	0.13 (3.3)	0.17 (4.3)	0.17 (4.3)	0.22 (5.6)
DT	0.13 (3.3)	0.13 (3.3)	0.17 (4.3)	0.17 (4.3)
H	1.07 (27.2)	1.38 (35.1)	1.58 (40.1)	1.97 (50.0)
HS	0.30 (7.6)	0.31 (7.9)	0.41 (10.4)	0.53 (13.5)
L1	3.38 (85.9)	4.39 (111.5)	4.70 (119.4)	5.39 (136.9)
L2	5.02 (127.5)	6.49 (164.8)	6.76 (171.7)	7.55 (191.8)
LB	0.63 (16.0)	0.71 (18.0)	0.94 (23.9)	1.42 (36.1)
LS	0.83 (21.1)	0.98 (24.9)	1.18 (30.0)	2.01 (51.1)
LT	0.75 (19.1)	1.30 (33.0)	1.37 (34.8)	1.61 (40.9)
T	0.71 (18.0)	0.87 (22.1)	1.06 (26.9)	1.34 (34.0)
TO	0.06 (1.5)	0.06 (1.5)	0.16 (4.1)	0.16 (4.1)
TU	0.50 (12.7)	0.65 (16.5)	0.80 (20.3)	1.07 (27.2)
W	1.32 (33.5)	1.51 (38.4)	1.54 (39.1)	1.73 (43.9)

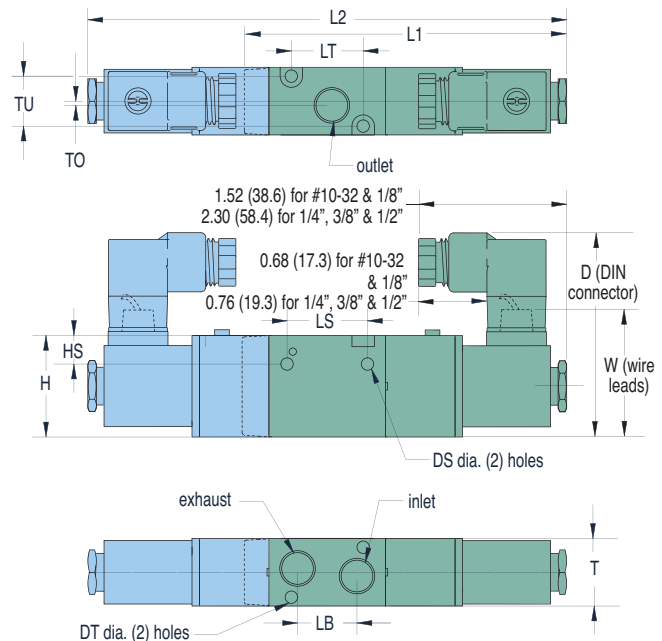

Single Solenoid Valves		Double Solenoid Valves		Inlet	Outlet	Exhaust	Cv/scfm*
MME-31NES-		MME-31NEE-		#10-32	#10-32	#10-32	0.58/27
MME-31PES-		MME-31PEE-		1/8" NPT	1/8" NPT	1/8" NPT	0.67/31
MME-32QES-		MME-32QEE-		1/4" NPT	1/4" NPT	1/4" NPT	0.89/49
MME-33WES-		MME-33WEE-		3/8" NPT	3/8" NPT	3/8" NPT	1.68/93
MME-34ZES-		MME-34ZEE-		1/2" NPT	1/2" NPT	1/2" NPT	2.79/171

* scfm based on flow @ 100 psig

Add Electrical Connection and Voltage Choices to the end of each Base Part Number - Example: **MME-34ZEE-W024**



2-Position Single Solenoid Valves

1/4" & 3/8" NAMUR Style



MME-33WESB-D012

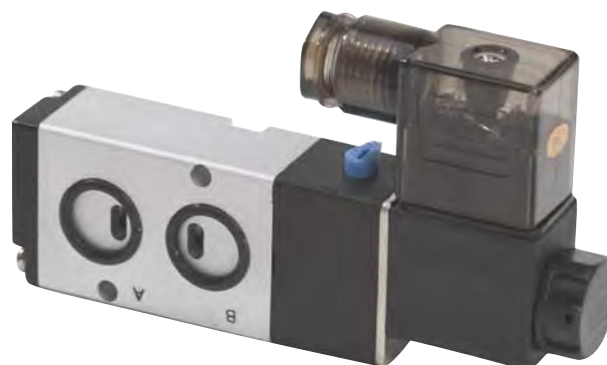

MME-32QESB-D220

Maximatic® 3-way and 4-way single solenoid spring return spool valves are also available in 1/4" NPT actuator mount or 3/8" NAMUR mount.

Medium: Air (40 micron filtration) or Inert Gas

Operating Range: 20 to 125 psig

Electrical Connection: DIN terminal with LED indicator ("-D"), or Grommet with 18" Wire Lead ("-W")

Voltage: 12-volt DC ("-012"), 24-volt DC ("-024"), 24-volt AC ("-24A"), 110-volt AC ("-110"), or 220-volt AC ("-220")

Number of Ports: 3 or 5

Mounting: Actuator (1/4" NPT only) or NAMUR (3/8" NPT only).

Manual Override: Locking

Power Consumption: 3 Watts

NAMUR/Actuator mount available on other 3- and 4-way Electronic and Air Pilot valves—
Call for specifications.

3-Way Solenoid Valves

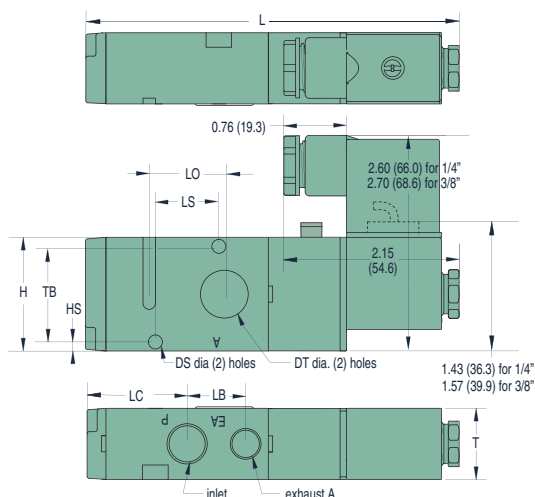

Dim.	1/4" NPT	3/8" NPT
DS	0.17 (4.3)	0.22 (5.6)
DT	0.72 (18.3)	0.78 (19.8)
H	1.38 (35.1)	1.58 (40.1)
HS	0.09 (2.3)	0.15 (3.8)
L	4.49 (114.0)	5.19 (131.8)
LC	1.21 (30.7)	1.57 (39.9)
LB	0.71 (18.0)	0.94 (23.9)
LO	0.91 (23.1)	0.94 (23.9)
LS	0.79 (20.1)	0.94 (23.9)
T	0.86 (21.8)	1.06 (26.9)
TB	1.14 (29.0)	1.26 (32.0)

4-Way Solenoid Valves

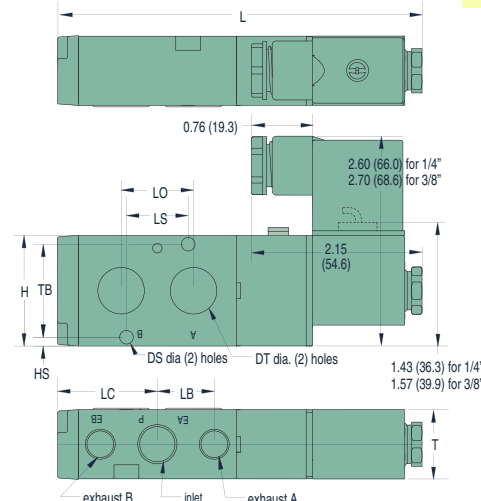

3-Way Single Solenoid Valves

MME-32QESB-
MME-33WESB-



Supply Port

1/4" NPT
3/8" NPT

Outlet

0.72"
0.78"

Exhaust

1/4" NPT
1/4" NPT

Cv/scfm*

0.89/49
1.68/93

4-Way Single Solenoid Valves

MME-42QESB-
MME-43WESB-

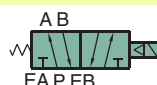

Supply Port

1/4" NPT
3/8" NPT

Outlet

0.72"
0.78"

Exhaust

1/4" NPT
1/4" NPT

Cv/scfm*

0.89/49
1.68/93

* scfm based on flow @ 100 psig

Add Electrical Connection and Voltage Choices to the end of each Base Part Number - Example: **MME-42QESB-D110**



MAXIMATIC® 4-WAY VALVES

2-Position Single & Double Solenoid Valves

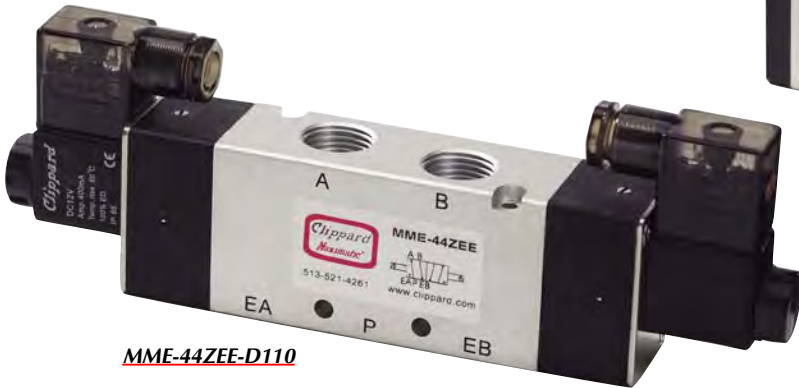

MME-44ZEE-D110



MME-44ZES-D012

Maximatic® 4-way solenoid controlled pilot operated valves are either single solenoid spring return or double solenoid spool valves in #10-32 thread to 1/2" NPT port sizes.

Medium: Air (40 micron filtration) or Inert Gas

Operating Range: 20 to 125 psig

Electrical Connection: DIN connector with LED indicator ("-D"), or 18" Wire Lead ("-W")

Voltage: 12-volt DC ("-012"), 24-volt DC ("-024"), 24-volt AC ("-24A"), 110-volt AC ("-110"), or 220-volt AC ("-220")

Number of Ports: 5

Mounting: Body Ported, Manifold Mount

Manual Override: Non-locking on MME-41 models. Locking on all other models.

Power Consumption: 2.5 Watts on MME-41 models; 3 Watts for all others.

Dim.	MME-41	MME-42	MME-43	MME-44
D	2.14 (54.4)	2.65 (67.3)	2.71 (68.8)	2.94 (74.7)
DS	0.13 (3.3)	0.17 (4.3)	0.17 (4.3)	0.21 (5.3)
DT	0.13 (3.3)	0.13 (3.3)	0.17 (4.3)	0.17 (4.3)
H	1.07 (27.2)	1.38 (35.1)	1.58 (40.1)	1.97 (50.0)
HS	0.16 (4.1)	0.28 (7.1)	0.26 (6.6)	0.29 (7.4)
L1	3.81 (96.8)	4.49 (114.0)	5.19 (131.8)	6.39 (162.3)
L2	5.54 (140.7)	6.49 (164.8)	7.24 (183.9)	8.48 (215.4)
LE	1.09 (27.7)	1.42 (36.1)	1.77 (45.0)	2.48 (63.0)
LO	0.63 (16.0)	0.74 (13.9)	0.96 (24.4)	1.42 (36.1)
LS	0.56 (14.2)	0.98 (24.9)	0.95 (24.1)	1.11 (28.2)
LT	1.18 (30.0)	1.40 (35.6)	1.97 (50.0)	2.82 (71.6)
T	0.71 (18.0)	0.86 (21.8)	1.06 (26.1)	1.34 (34.0)
TO	0.11 (2.8)	0.13 (3.3)	0.16 (4.1)	0.19 (4.8)
TU	0.50 (12.7)	0.65 (16.5)	0.80 (20.3)	1.07 (27.2)
W	1.32 (33.5)	1.51 (38.4)	1.54 (39.1)	1.73 (43.9)

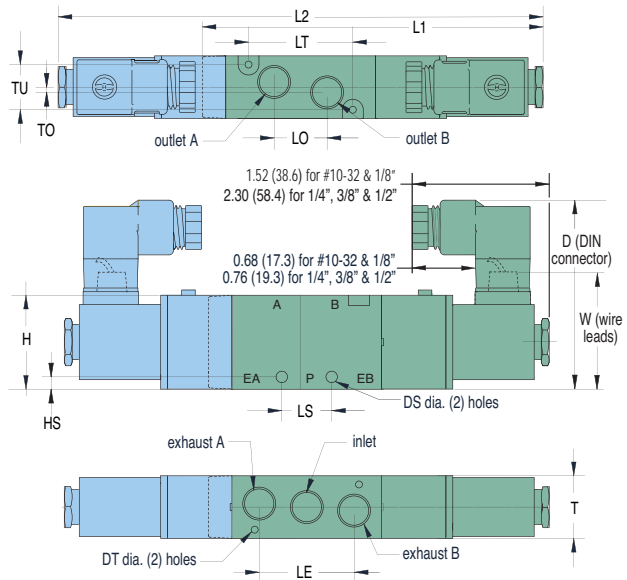

Single Solenoid Valves		Double Solenoid Valves		Inlet	Outlet	Exhaust	Cv/scfm*
<u>MME-41NES-</u>		<u>MME-41NEE-</u>		#10-32	#10-32	#10-32	0.58/27
<u>MME-41PES-</u>		<u>MME-41PEE-</u>		1/8" NPT	1/8" NPT	1/8" NPT	0.67/31
<u>MME-42QES-</u>		<u>MME-42QEE-</u>		1/4" NPT	1/4" NPT	1/8" NPT	0.89/49
<u>MME-43WES-</u>		<u>MME-43WEE-</u>		3/8" NPT	3/8" NPT	1/4" NPT	1.68/93
<u>MME-44ZES-</u>		<u>MME-44ZEE-</u>		1/2" NPT	1/2" NPT	1/2" NPT	2.79/171

* scfm based on flow @ 100 psig

Add Electrical Connection and Voltage Choices to the end of each Base Part Number - Example: **MME-43WEE-D110**

3-Position Spring Centered Double Solenoid Valves

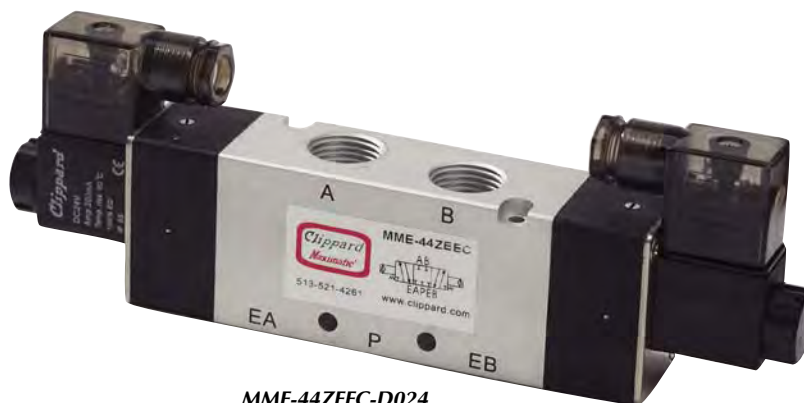

MME-44ZEEC-D024

Maximatic® 4-way double solenoid spring centered valves with closed center, pressure center or exhaust center spools are available from #10-32 thread to 1/2" NPT port sizes.

Medium: Air (40 micron filtration) or Inert Gas

Operating Range: 30 to 125 psig on MME-41 series, 20 to 125 psig on all others

Electrical Connection: DIN terminal with LED indicator ("-D"), or 18" Wire Lead ("-W")

Voltage: 12-volt DC ("-012"), 24-volt DC ("-024"), 24-volt AC ("-24A"), 110-volt AC ("-110"), or 220-volt AC ("-220")

Number of Ports: 5

Mounting: Body Ported, Manifold Mount

Manual Override: Non-locking on MME-41 Series. Locking on all other models.

Power Consumption: 2.5 Watts on MME-41 models; 3 Watts for all others.

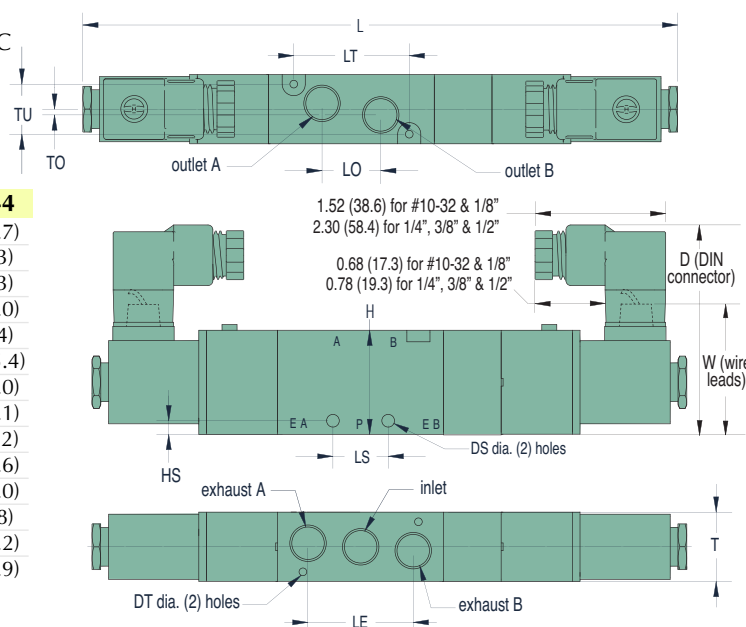

Dim.	MME-41	MME-42	MME-43	MME-44
D	2.14 (54.4)	2.65 (67.3)	2.71 (68.8)	2.94 (74.7)
DS	0.13 (3.3)	0.17 (4.3)	0.17 (4.3)	0.21 (5.3)
DT	0.13 (3.3)	0.13 (3.3)	0.17 (4.3)	0.17 (4.3)
H	1.07 (27.2)	1.38 (35.1)	1.58 (40.1)	1.97 (50.0)
HS	0.16 (4.1)	0.28 (7.1)	0.26 (6.6)	0.29 (7.4)
L	6.13 (155.7)	7.24 (183.9)	7.98 (202.7)	8.48 (215.4)
LE	1.09 (27.7)	1.42 (36.1)	1.77 (45.0)	2.48 (63.0)
LO	0.63 (16.0)	0.74 (18.8)	0.96 (24.4)	1.42 (36.1)
LS	0.56 (14.2)	0.98 (24.9)	0.95 (24.1)	1.11 (28.2)
LT	1.18 (30.0)	1.40 (35.6)	1.97 (50.0)	2.82 (71.6)
T	0.71 (18.0)	0.86 (21.8)	1.06 (26.9)	1.34 (34.0)
TO	0.11 (2.8)	0.13 (3.3)	0.16 (4.1)	0.19 (4.8)
TU	0.50 (12.7)	0.65 (16.5)	0.80 (20.3)	1.07 (27.2)
W	1.32 (33.5)	1.51 (38.4)	1.54 (39.1)	1.73 (43.9)



Closed Center	Pressure Center	Exhaust Center	Inlet	Outlet	Exhaust	Cv/scfm*
<u>MME-41NEEC-</u>	<u>MME-41NEEP-</u>	<u>MME-41NEEE-</u>	#10-32	#10-32	#10-32	0.50/23
<u>MME-41PEEC-</u>	<u>MME-41PEEP-</u>	<u>MME-41PEEE-</u>	1/8" NPT	1/8" NPT	1/8" NPT	0.50/23
<u>MME-42QECC-</u>	<u>MME-42QECP-</u>	<u>MME-42QECE-</u>	1/4" NPT	1/4" NPT	1/8" NPT	0.89/49
<u>MME-43WECC-</u>	<u>MME-43WECP-</u>	<u>MME-43WEEC-</u>	3/8" NPT	3/8" NPT	1/4" NPT	1.00/72
<u>MME-44ZECC-</u>	<u>MME-44ZEEP-</u>	<u>MME-44ZEEC-</u>	1/2" NPT	1/2" NPT	1/2" NPT	1.68/93

* scfm based on flow @ 100 psig

Add Electrical Connection and Voltage Choices to the end of each Base Part Number - Example: **MME-41PEEP-W024**



MAXIMATIC® VALVE ACCESSORIES

Rebuild Kits. Convenient rebuild kits are available which contain common maintenance items that may be needed during the life of the valve. Each contains a spool, diamond seal, two pilot seals, two pistons with seals, and spring. Consult factory for 3-position kits.

Part No.	Description
27040-31	3-Way Kit, MME-31
27040-32	3-Way Kit, MME-32
27040-33	3-Way Kit, MME-33
27040-34	3-Way Kit, MME-34
27040-41	4-Way 2 Pos. Kit, MME-41
27040-42	4-Way 2 Pos. Kit, MME-42
27040-43	4-Way 2 Pos. Kit, MME-43
27040-44	4-Way 2 Pos. Kit, MME-44

Parallel Bar Manifolds

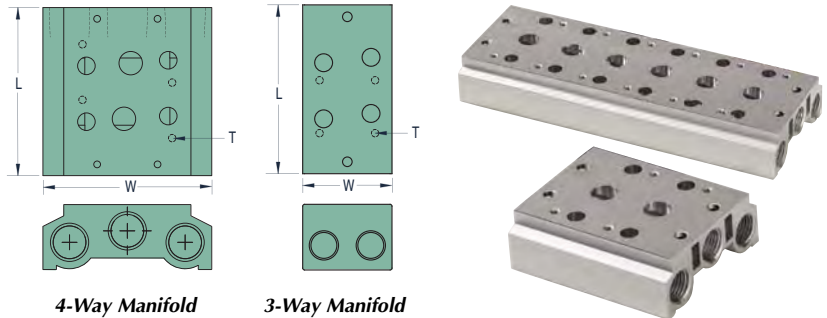

Valve Series	"L" Dimension					"T" Mtg. Thd.
	2-Station	4-Station	6-Station	8-Station	16-Station	
MME-31/41	2.24 (56.9)	3.73 (94.7)	5.25 (133.4)	6.75 (171.5)	12.69 (322.3)	M4
MME-32/42	2.71 (68.8)	4.50 (114.3)	6.33 (160.8)	8.13 (206.5)	15.38 (390.7)	M4
MME-33/43	3.22 (81.8)	5.42 (137.7)	7.62 (193.5)	9.82 (249.4)	18.63 (473.2)	M5
MME-34/44	3.85 (97.8)	6.56 (166.6)	9.38 (238.3)	12.10 (307.3)	23.11 (587.0)	M5

Parallel circuit manifold bars are available for all sizes of MME 3- and 4-way valves. Manifolds are made in increments of two stations from 2 to 16, and are supplied with mounting screws and gaskets. Spare kits are also available which include two screws and a gasket. Blank plate supplied with one gasket, two screws and metal plate.

Valve Series	Manifold Inlet/						
	Exhaust	Blank Plate	2-Station	4-Station	6-Station	8-Station	16-Station
3-Way Valve Manifolds							
MME-31	1/8"	MMM-31-B	MMM-31-02	MMM-31-04	MMM-31-06	MMM-31-08	MMM-31-16
MME-32	1/4"	MMM-32-B	MMM-32-02	MMM-32-04	MMM-32-06	MMM-32-08	MMM-32-16
MME-33	3/8"	MMM-33-B	MMM-33-02	MMM-33-04	MMM-33-06	MMM-33-08	MMM-33-16
MME-34	1/2"	MMM-34-B	MMM-34-02	MMM-34-04	MMM-34-06	MMM-34-08	MMM-34-16

3-Way Spare Mounting Kit Hardware

27041-31 Hardware Kit for MME-31 Series Valves	27041-33 Hardware Kit for MME-33 Series Valves
27041-32 Hardware Kit for MME-32 Series Valves	27041-34 Hardware Kit for MME-34 Series Valves

Valve Series	Manifold Inlet/						
	Exhaust	Blank Plate	2-Station	4-Station	6-Station	8-Station	16-Station
4-Way Valve Manifolds							
MME-41	1/4"	MMM-41-B	MMM-41-02	MMM-41-04	MMM-41-06	MMM-41-08	MMM-41-16
MME-42	1/4"	MMM-42-B	MMM-42-02	MMM-42-04	MMM-42-06	MMM-42-08	MMM-42-16
MME-43	3/8"	MMM-43-B	MMM-43-02	MMM-43-04	MMM-43-06	MMM-43-08	MMM-43-16
MME-44	1/2"	MMM-44-B	MMM-44-02	MMM-44-04	MMM-44-06	MMM-44-08	MMM-44-16

4-Way Spare Mounting Kit Hardware

27041-41 Hardware Kit for MME-41 Series Valves	27041-43 Hardware Kit for MME-43 Series Valves
27041-42 Hardware Kit for MME-42 Series Valves	27041-44 Hardware Kit for MME-44 Series Valves



Replacement Coils



Industrial Form
2.5 Watt
#10-32 & 1/8"

Form B
3.0 Watt
1/4", 3/8" & 1/2"

Form B
6.5 Watt
Direct-Acting

Replacement coils for solenoid valves are available in volt-ages from 12 VDC to 220 VAC with either DIN connector or 18" wire leads. Refer to DIN Connectors below.

Description	2.5 Watt #10-32 & 1/8"	3.0 Watt 1/4", 3/8" & 1/2"	6.5 Watt Direct-Acting
DIN Connectors			
12-Volt DC	27001-D012	27065-D012	27002-D012
24-Volt DC	27001-D024	27065-D024	27002-D024
110-Volt AC	27001-D110	27065-D110	27002-D110
220-Volt AC	27001-D220	27065-D220	27002-D220
24-Volt AC	27001-D24A	27065-D24A	27002-D24A
Wire Leads			
12-Volt DC	27001-W012	27065-W012	27002-W012
24-Volt DC	27001-W024	27065-W024	27002-W024
110-Volt AC	27001-W110	27065-W110	27002-W110
220-Volt AC	27001-W220	27065-W220	27002-W220
24-Volt AC	27001-W24A	27065-W24A	27002-W24A

DIN Connectors

DIN 43650 Form B Connectors with 11 mm spade center spacing. DIN type size 2, 3 and 4 Maximatic valves. Industrial Form Connectors with 9.4 mm spade center spacing are designed to connect to 15 mm terminal coils. Both are available with or without surge suppression, and 152 or 381 mm PVC molded three-wire cord set.



Form B Part No.	Industrial Form Part No.	Volts	LED	Cord
CC-B	CC-I			-
CC-B-P6	CC-I-P6	6-240	no	6'
CC-B-P15	CC-I-P15			15'
CC-BLL	CC-ILL			-
CC-BLL-P6	CC-ILL-P6	6-24	yes	6'
CC-BLL-P15	CC-ILL-P15			15'
CC-BLM	CC-ILM			-
CC-BLM-P6	CC-ILM-P6	48-110	yes	6'
CC-BLM-P15	CC-ILM-P15			15'
CC-BLH				-
CC-BLH-P6		208-240	yes	6'
CC-BLH-P15				15'

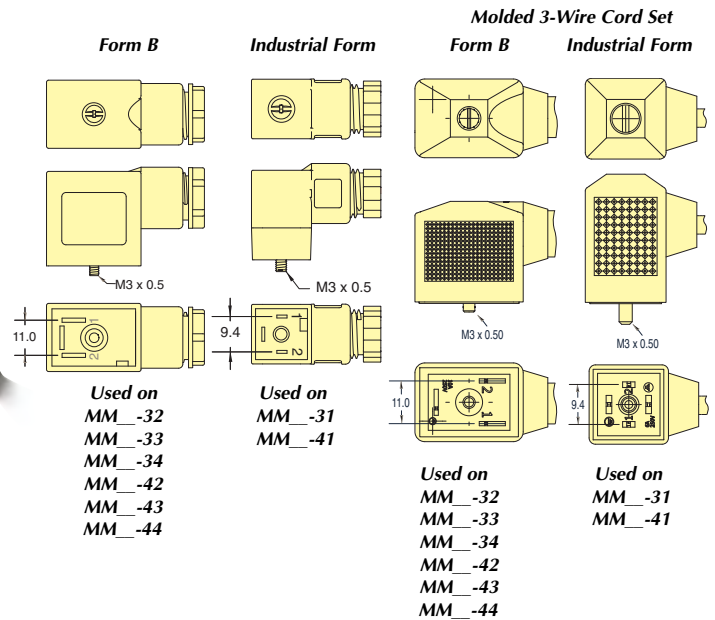

Sub-Assemblies & Kits

Call Clippard to inquire more about our Value Added services.





NEW! Exhaust Mufflers

For quiet system operation, see [page 312](#) for effective exhaust mufflers.



NEW! Speed Control Mufflers

For quiet system operation with speed control, see [page 164](#).



Push-Quick Fittings

See [pages 290 through 298](#) for a complete selection of easy-to-install Push-Quick Fittings.